



Contents

Folding Mobile Tables

Kite®	04
Mini Mobile	09
Kite Wave	11

Non-folding Tables

Versatilis	13
Versatilis Butcher Block	24
Versatilis Bot Builder	26
Q-rise	31

Power

Qpac	28
Q-dock	29
ReCharge	29
Juice Tree®	30
Juice Bot®	30
Powerball	32

Storage

Go Storage	33
Stash	41
Stashbox	43
Stash Cubby	43
Innov-8	44

Education Seating

MBob family	45
K-family (K-stool K-seat)	47

Soft Seating and Side Tables

Lips	49
R2	49
Puzzle	50
Giant Donut	50
Signs	51
Bebop	54
Daywalker	55
Space Chicken / XL	55

Acoustic Seating and Space Dividers

Waltzer	56
Woodland	58
Box Lounger	58
M-Pod	59
Nook	59

Seating

LJ1, LJ2, LJ3	60
Switch	62

Walls and Writable Surfaces

Riveli	63
PXL	63
Flow	64

Indoor/Outdoor

A-frame	65
A-Frame Demountable	65
Alfresco Bench	66
Alfresco Mini	66
Angle	67
Block	67
Box planter	68
Drum planter	68
Edge	69
Linear	69
Ping-Pong	70
Tall Trestle	70
Tall Tri Stool	71
Trestle	71
Town	72
Java	72
Love Seat	73
Hot Seat	73
Switcher	74
Flomo	75
Xbrick	75
Xbench and Xtable	76
Shadowspac Umbrella	77
Finishes	81

How to use the pricebook

When ordering Kite, Mini Mobile or Versatilis

We have combined Tall, Low and Standard heights all on one page.
We have ordered the options by height, so you can now easily see and select the options of a table shape from the comfort of one page.

See the following example;

Height	Legs	Code	Tier 1	Tier 2	Tier 3
29"	Silver	KTK/75/SS	1668	1856	2072
	Graphite	KTK/75/SGR	1668	1856	2072
	Black	KTK/75/SBL	1668	1856	2072
	White	KTK/75/SWH	1794	1982	2198
	Eco	KTK/75/ECO	1794	1982	2198
	Chrome	KTK/75/SCH	1911	2099	2314
Tapered Silver	KTK/75/TSL	2092	2280	2495	
36"	Silver	KTK/36/75/SS	1966	2154	2369
	Graphite	KTK/36/75/SGR	1966	2154	2369
	Black	KTK/36/75/SBL	1966	2154	2369
	White	KTK/36/75/SWH	2092	2280	2495
	Eco	KTK/36/75/ECO	2092	2280	2495

I'd like a 29 inch high Kite table with Straight Graphite legs and a Tier 1 top. (I refer to the finishes for Kite and select Designer White which gives me the code /DW to add on.

My final product code is: KTK/75/SGR/DW

The price is already worked out as shown \$1668

Information

All prices are in USD.

All dimensions are in inches.

Version

2025

Features

Links

On the footer of each pricing page you will find handy links you can click to jump to that page. Making it easier for you to navigate around.

 Contents

This takes you straight to the contents page.

 Finishes

This takes you to the product finishes page.

When on the contents page, simply click the product name get to the product price page.

When on a finishes page, the  symbol link to go to the product page.

750 Kite shape folding table

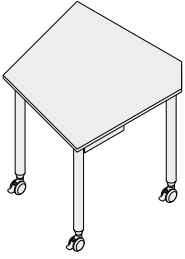

Height	Legs	Code	Tier 1	Tier 2	Tier 3
29"	Silver	KTK/75/SS	1668	1856	2072
	Graphite	KTK/75/SGR	1668	1856	2072
	Black	KTK/75/SBL	1668	1856	2072
	White	KTK/75/SWH	1794	1982	2198
	Eco	KTK/75/ECO	1794	1982	2198
	Chrome	KTK/75/SCH	1911	2099	2314
	Tapered Silver	KTK/75/TSL	2092	2280	2495
36"	Silver	KTK/36/75/SS	1966	2154	2369
	Graphite	KTK/36/75/SGR	1966	2154	2369
	Black	KTK/36/75/SBL	1966	2154	2369
	White	KTK/36/75/SWH	2092	2280	2495
	Eco	KTK/36/75/ECO	2092	2280	2495
41"	Silver	KTK/41/75/SS	1966	2154	2369
	Graphite	KTK/41/75/SGR	1966	2154	2369
	Black	KTK/41/75/SBL	1966	2154	2369
	White	KTK/41/75/SWH	2092	2280	2495
	Eco	KTK/41/75/ECO	2092	2280	2495

Dimensions – Width 29.5" Depth 29.5"

Links

[← Contents](#)
[↗ Finishes](#)

750 Rectangle folding table (1500)

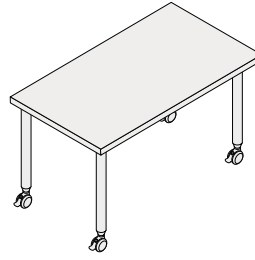

Height	Legs	Code	Tier 1	Tier 2	Tier 3
29"	Silver	KTR/75150/SS	1519	1670	1898
	Graphite	KTR/75150/SGR	1519	1670	1898
	Black	KTR/75150/SBL	1519	1670	1898
	White	KTR/75150/SWH	1645	1796	2024
	Eco	KTR/75150/ECO	1645	1796	2024
	Chrome	KTR/75150/SCH	1762	1912	2140
	Tapered Silver	KTR/75150/TSL	1943	2093	2321
36"	Silver	KTR/36/75150/SS	1817	1967	2195
	Graphite	KTR/36/75150/SGR	1817	1967	2195
	Black	KTR/36/75150/SBL	1817	1967	2195
	White	KTR/36/75150/SWH	1817	1967	2195
	Eco	KTR/36/75150/ECO	1943	2093	2321
41"	Silver	KTR/41/75150/SS	1817	1967	2195
	Graphite	KTR/41/75150/SGR	1817	1967	2195
	Black	KTR/41/75150/SBL	1817	1967	2195
	White	KTR/41/75150/SWH	1817	1967	2195
	Eco	KTR/41/75150/ECO	1943	2093	2321
27"	Silver	KTR/27/75150/SS	1519	1670	1898
	Graphite	KTR/27/75150/SGR	1519	1670	1898
	Black	KTR/27/75150/SBL	1519	1670	1898
	White	KTR/27/75150/SWH	1519	1670	1898
	Eco	KTR/27/75150/ECO	1645	1796	2024

Dimensions – Width 59" Depth 29.5"

Links

[← Contents](#)
[↗ Finishes](#)

Kite®

750 Square folding table

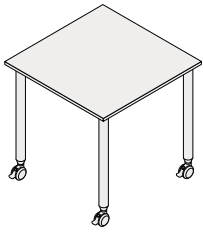

Height	Legs	Code	Tier 1	Tier 2	Tier 3
29"	Silver	KTS/7575/SS	1364	1499	1704
	Graphite	KTS/7575/SGR	1364	1499	1704
	Black	KTS/7575/SBL	1364	1499	1704
	White	KTS/7575/SWH	1490	1625	1830
	Eco	KTS/7575/ECO	1490	1625	1830
	Chrome	KTS/7575/SCH	1607	1742	1947
	Tapered Silver	KTS/7575/TSL	1787	1923	2127
36"	Silver	KTS/36/7575/SS	1661	1797	2001
	Graphite	KTS/36/7575/SGR	1661	1797	2001
	Black	KTS/36/7575/SBL	1661	1797	2001
	White	KTS/36/7575/SWH	1787	1923	2127
	Eco	KTS/36/7575/ECO	1787	1923	2127
41"	Silver	KTS/41/7575/SS	1661	1797	2001
	Graphite	KTS/41/7575/SGR	1661	1797	2001
	Black	KTS/41/7575/SBL	1661	1797	2001
	White	KTS/41/7575/SWH	1787	1923	2127
	Eco	KTS/41/7575/ECO	1787	1923	2127
27"	Silver	KTS/27/7575/SS	1364	1499	1704
	Graphite	KTS/27/7575/SGR	1364	1499	1704
	Black	KTS/27/7575/SBL	1364	1499	1704
	White	KTS/27/7575/SWH	1490	1625	1830
	Eco	KTS/27/7575/ECO	1490	1625	1830

Dimensions – Width 29.5" Depth 29.5"

Links

[← Contents](#) [↗ Finishes](#)

Kite®

1500 Semi-circle folding table

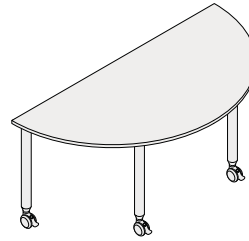

Height	Legs	Code	Tier 1	Tier 2	Tier 3
29"	Silver	KTSC/75150/SS	1668	1856	2072
	Graphite	KTSC/75150/SGR	1668	1856	2072
	Black	KTSC/75150/SBL	1668	1856	2072
	White	KTSC/75150/SWH	1794	1982	2198
	Eco	KTSC/75150/ECO	1794	1982	2198
	Chrome	KTSC/75150/SCH	1911	2099	2314
	Tapered Silver	KTSC/75150/TSL	2092	2280	2495
36"	Silver	KTSC/36/75150/SS	1966	2154	2369
	Graphite	KTSC/36/75150/SGR	1966	2154	2369
	Black	KTSC/36/75150/SBL	1966	2154	2369
	White	KTSC/36/75150/SWH	2092	2280	2495
	Eco	KTSC/36/75150/ECO	2092	2280	2495
41"	Silver	KTSC/41/75150/SS	1966	2154	2369
	Graphite	KTSC/41/75150/SGR	1966	2154	2369
	Black	KTSC/41/75150/SBL	1966	2154	2369
	White	KTSC/41/75150/SWH	2092	2280	2495
	Eco	KTSC/41/75150/ECO	2092	2280	2495
27"	Silver	KTSC/27/75150/SS	1668	1856	2072
	Graphite	KTSC/27/75150/SGR	1668	1856	2072
	Black	KTSC/27/75150/SBL	1668	1856	2072
	White	KTSC/27/75150/SWH	1794	1982	2198
	Eco	KTSC/27/75150/ECO	1794	1982	2198

Dimensions – Width 59" Depth 29.5"

Links

[← Contents](#) [↗ Finishes](#)

750 Rectangle folding table (1300)

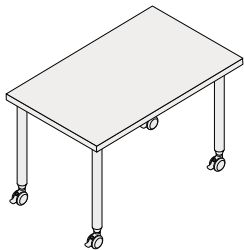

Height	Legs	Code	Tier 1	Tier 2	Tier 3
29"	Silver	KTR/75130/SS	1513	1662	1888
	Graphite	KTR/75130/SGR	1513	1662	1888
	Black	KTR/75130/SBL	1513	1662	1888
	White	KTR/75130/SWH	1639	1788	2014
	Eco	KTR/75130/ECO	1639	1788	2014
	Chrome	KTS/75130/SCH	1755	1905	2130
	Tapered Silver	KTR/75130/TSL	1934	2085	2311
36"	Silver	KTR/36/75130/SS	1809	1959	2185
	Graphite	KTR/36/75130/SGR	1809	1959	2185
	Black	KTR/36/75130/SBL	1809	1959	2185
	White	KTR/36/75130/SWH	1935	2085	2311
	Eco	KTR/36/75130/ECO	1935	2085	2311
41"	Silver	KTR/41/75130/SS	1809	1959	2185
	Graphite	KTR/41/75130/SGR	1809	1959	2185
	Black	KTR/41/75130/SBL	1809	1959	2185
	White	KTR/41/75130/SWH	1935	2085	2311
	Eco	KTR/41/75130/ECO	1935	2085	2311
27"	Silver	KTR/27/75130/SS	1513	1662	1888
	Graphite	KTR/27/75130/SGR	1513	1662	1888
	Black	KTR/27/75130/SBL	1513	1662	1888
	White	KTR/27/75130/SWH	1639	1788	2014
	Eco	KTR/27/75130/ECO	1639	1788	2014

Dimensions – Width 51" Depth 29.5"

Links

[← Contents](#) [↗ Finishes](#)

Kite®

650 Rectangle folding table (1500)

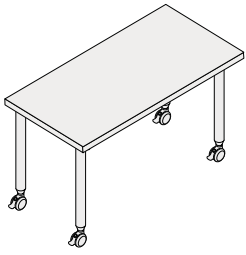

Height	Legs	Code	Tier 1	Tier 2	Tier 3
29"	Silver	KTR/65150/SS	1513	1655	1888
	Graphite	KTR/65150/SGR	1513	1655	1888
	Black	KTR/65150/SBL	1513	1655	1888
	White	KTR/65150/SWH	1639	1781	2014
	Eco	KTR/65150/ECO	1639	1781	2014
	Chrome	KTR/65150/SCH	1755	1897	2130
	Tapered Silver	KTR/65150/TSL	1934	2078	2311
36"	Silver	KTR/36/65150/SS	1809	1952	2185
	Graphite	KTR/36/65150/SGR	1809	1952	2185
	Black	KTR/36/65150/SBL	1809	1952	2185
	White	KTR/36/65150/SWH	1935	2075	2311
	Eco	KTR/36/65150/ECO	1935	2075	2311
41"	Silver	KTR/41/65150/SS	1809	1952	2185
	Graphite	KTR/41/65150/SGR	1809	1952	2185
	Black	KTR/41/65150/SBL	1809	1952	2185
	White	KTR/41/65150/SWH	1935	2075	2311
	Eco	KTR/41/65150/ECO	1935	2075	2311
27"	Silver	KTR/27/65150/SS	1513	1655	1888
	Graphite	KTR/27/65150/SGR	1513	1655	1888
	Black	KTR/27/65150/SBL	1513	1655	1888
	White	KTR/27/65150/SWH	1639	1781	2014
	Eco	KTR/27/65150/ECO	1639	1781	2014
25"	Silver	KTR/25/65150/SS	1513	1655	1888
	Graphite	KTR/25/65150/SGR	1513	1655	1888
	Black	KTR/25/65150/SBL	1513	1655	1888
	White	KTR/25/65150/SWH	1639	1781	2014
	Eco	KTR/25/65150/ECO	1639	1781	2014

Dimensions – Width 59" Depth 25.5"

Links

[← Contents](#) [↗ Finishes](#)

Kite®

650 Rectangle folding table (1300)

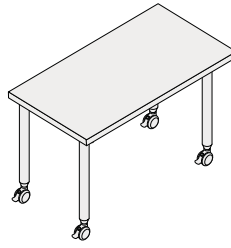

Height	Legs	Code	Tier 1	Tier 2	Tier 3
29"	Silver	KTR/65130/SS	1475	1630	1860
	Graphite	KTR/65130/SGR	1475	1630	1860
	Black	KTR/65130/SBL	1475	1630	1860
	White	KTR/65130/SWH	1601	1756	1986
	Eco	KTR/65130/ECO	1601	1756	1986
	Chrome	KTR/65130/SCH	1718	1872	2102
	Tapered Silver	KTR/65130/TSL	1898	2053	2283
36"	Silver	KTR/36/65130/SS	1772	1927	2157
	Graphite	KTR/36/65130/SGR	1772	1927	2157
	Black	KTR/36/65130/SBL	1772	1927	2157
	White	KTR/36/65130/SWH	1898	2053	2283
	Eco	KTR/36/65130/ECO	1898	2053	2283
41"	Silver	KTR/41/65130/SS	1772	1927	2157
	Graphite	KTR/41/65130/SGR	1772	1927	2157
	Black	KTR/41/65130/SBL	1772	1927	2157
	White	KTR/41/65130/SWH	1898	2053	2283
	Eco	KTR/41/65130/ECO	1898	2053	2283
27"	Silver	KTR/27/65130/SS	1475	1630	1860
	Graphite	KTR/27/65130/SGR	1475	1630	1860
	Black	KTR/27/65130/SBL	1475	1630	1860
	White	KTR/27/65130/SWH	1601	1756	1986
	Eco	KTR/27/65130/ECO	1601	1756	1986
25"	Silver	KTR/25/65130/SS	1475	1630	1860
	Graphite	KTR/25/65130/SGR	1475	1630	1860
	Black	KTR/25/65130/SBL	1475	1630	1860
	White	KTR/25/65130/SWH	1601	1756	1986
	Eco	KTR/25/65130/ECO	1601	1756	1986

Dimensions – Width 51" Depth 25.5"

Links

[← Contents](#) [↗ Finishes](#)

Kite®

650 small rectangle folding table

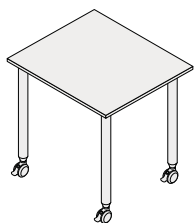

Height	Legs	Code	Tier 1	Tier 2	Tier 3
29"	Silver	KTR/6575/SS	1364	1499	1705
	Graphite	KTR/6575/SGR	1364	1499	1705
	Black	KTR/6575/SBL	1364	1499	1705
	White	KTR/6575/SWH	1490	1625	1831
	Eco	KTR/6575/ECO	1490	1625	1831
	Chrome	KTR/6575/SCH	1607	1742	1947
	Tapered Silver	KTR/6575/TSL	1787	1923	2127
36"	Silver	KTR/36/6575/SS	1661	1797	2001
	Graphite	KTR/36/6575/SGR	1661	1797	2001
	Black	KTR/36/6575/SBL	1661	1797	2001
	White	KTR/36/6575/SWH	1787	1923	2127
	Eco	KTR/36/6575/ECO	1787	1923	2127
41"	Silver	KTR/41/6575/SS	1661	1797	2001
	Graphite	KTR/41/6575/SGR	1661	1797	2001
	Black	KTR/41/6575/SBL	1661	1797	2001
	White	KTR/41/6575/SWH	1787	1923	2127
	Eco	KTR/41/6575/ECO	1787	1923	2127
27"	Silver	KTR/27/6575/SS	1364	1499	1705
	Graphite	KTR/27/6575/SGR	1364	1499	1705
	Black	KTR/27/6575/SBL	1364	1499	1705
	White	KTR/27/6575/SWH	1490	1625	1831
	Eco	KTR/27/6575/ECO	1490	1625	1831
25"	Silver	KTR/25/6575/SS	1364	1499	1705
	Graphite	KTR/25/6575/SGR	1364	1499	1705
	Black	KTR/25/6575/SBL	1364	1499	1705
	White	KTR/25/6575/SWH	1490	1625	1831
	Eco	KTR/25/6575/ECO	1490	1625	1831

Dimensions – Width 29.5" Depth 25.5"

Links

[← Contents](#) [↗ Finishes](#)

Kite®

650 boat end folding table (1300)

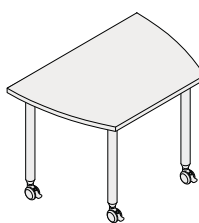

Height	Legs	Code	Tier 1	Tier 2	Tier 3
29"	Silver	KTB/65130/SS	1622	1786	1922
	Graphite	KTB/65130/SGR	1622	1786	1922
	Black	KTB/65130/SBL	1622	1786	1922
	White	KTB/65130/SWH	1748	1912	2048
	Eco	KTB/65130/ECO	1748	1912	2048
36"	Silver	KTB/36/65130/SS	1918	2081	2218
	Graphite	KTB/36/65130/SGR	1918	2081	2218
	Black	KTB/36/65130/SBL	1918	2081	2218
	White	KTB/36/65130/SWH	2044	2207	2344
	Eco	KTB/36/65130/ECO	2044	2207	2344
41"	Silver	KTB/41/65130/SS	1918	2081	2218
	Graphite	KTB/41/65130/SGR	1918	2081	2218
	Black	KTB/41/65130/SBL	1918	2081	2218
	White	KTB/41/65130/SWH	2044	2207	2344
	Eco	KTB/41/65130/ECO	2044	2207	2344

Dimensions – Width 51" Depth 29.5"

Links

[← Contents](#) [↗ Finishes](#)

Mini Mobile

1050 Circle folding table

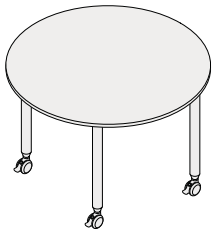

Height	Legs	Code	Tier 1	Tier 2	Tier 3
29"	Silver	MMFC/105/SS	1455	1600	1817
	Graphite	MMFC/105/SGR	1455	1600	1817
	Black	MMFC/105/SBL	1455	1600	1817
	White	MMFC/105/SWH	1581	1726	1943
	Eco	MMFC/105/ECO	1581	1726	1943
	Chrome	MMFC/105/SCH	1697	1843	2058
36"	Silver	MMFC/36/105/SS	1751	1897	2113
	Graphite	MMFC/36/105/SGR	1751	1897	2113
	Black	MMFC/36/105/SBL	1751	1897	2113
	White	MMFC/36/105/SWH	1877	2023	2239
	Eco	MMFC/36/105/ECO	1877	2023	2239
41"	Silver	MMFC/41/105/SS	1751	1897	2113
	Graphite	MMFC/41/105/SGR	1751	1897	2113
	Black	MMFC/41/105/SBL	1751	1897	2113
	White	MMFC/41/105/SWH	1877	2023	2239
	Eco	MMFC/41/105/ECO	1877	2023	2239

Dimensions – Width 41.5" Depth 41.5"

Links

[← Contents](#) [↗ Finishes](#)

Mini Mobile

1050 Crescent folding table

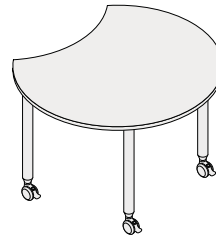

Height	Legs	Code	Tier 1	Tier 2	Tier 3
29"	Silver	MMCT/105/SS	1455	1600	1817
	Graphite	MMCT/105/SGR	1455	1600	1817
	Black	MMCT/105/SBL	1455	1600	1817
	White	MMCT/105/SWH	1581	1726	1943
	Eco	MMCT/105/ECO	1581	1726	1943
	Chrome	MMCT/105/SCH	1697	1843	2058
36"	Silver	MMCT/36/105/SS	1751	1897	2113
	Graphite	MMCT/36/105/SGR	1751	1897	2113
	Black	MMCT/36/105/SBL	1751	1897	2113
	White	MMCT/36/105/SWH	1877	2023	2239
	Eco	MMCT/36/105/ECO	1877	2023	2239
41"	Silver	MMCT/41/105/SS	1751	1897	2113
	Graphite	MMCT/41/105/SGR	1751	1897	2113
	Black	MMCT/41/105/SBL	1751	1897	2113
	White	MMCT/41/105/SWH	1877	2023	2239
	Eco	MMCT/41/105/ECO	1877	2023	2239
27"	Silver	MMCT/27/105/SS	1455	1600	1817
	Graphite	MMCT/27/105/SGR	1455	1600	1817
	Black	MMCT/27/105/SBL	1455	1600	1817
	White	MMCT/27/105/SWH	1581	1726	1943
	Eco	MMCT/27/105/ECO	1581	1726	1943

Dimensions – Width 41.5" Depth 37"

Links

[← Contents](#) [↗ Finishes](#)

Mini Mobile

850 Circle folding table

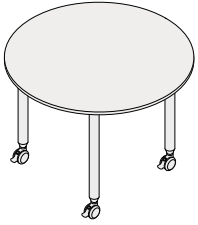

Height	Legs	Code	Tier 1	Tier 2	Tier 3
29"	Silver	MMFC/85/SS	1257	1383	1571
	Graphite	MMFC/85/SGR	1257	1383	1571
	Black	MMFC/85/SBL	1257	1383	1571
	White	MMFC/85/SWH	1383	1509	1697
	Eco	MMFC/85/ECO	1383	1509	1697
	Chrome	MMFC/85/SCH	1499	1625	1812
27"	Silver	MMFC/27/85/SS	1257	1383	1571
	Graphite	MMFC/27/85/SGR	1257	1383	1571
	Black	MMFC/27/85/SBL	1257	1383	1571
	White	MMFC/27/85/SWH	1383	1509	1697
	Eco	MMFC/27/85/ECO	1383	1509	1697

Dimensions – Width 33.5" Depth 33.5"

Links

[← Contents](#) [↗ Finishes](#)

Mini Mobile

850 Crescent folding table

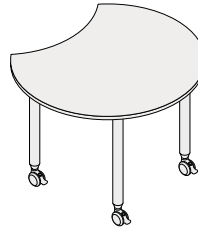

Height	Legs	Code	Tier 1	Tier 2	Tier 3
29"	Silver	MMCT/85/SS	1257	1383	1571
	Graphite	MMCT/85/SGR	1257	1383	1571
	Black	MMCT/85/SBL	1257	1383	1571
	White	MMCT/85/SWH	1383	1509	1697
	Eco	MMCT/85/ECO	1383	1509	1697
	Chrome	MMCT/85/SCH	1499	1625	1812
27"	Silver	MMCT/27/85/SS	1257	1383	1571
	Graphite	MMCT/27/85/SGR	1257	1383	1571
	Black	MMCT/27/85/SBL	1257	1383	1571
	White	MMCT/27/85/SWH	1383	1509	1697
	Eco	MMCT/27/85/ECO	1383	1509	1697
	25"	Silver	MMCT/25/85/SS	1257	1383
Graphite		MMCT/25/85/SGR	1257	1383	1571
Black		MMCT/25/85/SBL	1257	1383	1571
White		MMCT/25/85/SWH	1383	1509	1697
Eco		MMCT/25/85/ECO	1383	1509	1697

Dimensions – Width 33.5" Depth 30"

Links

[← Contents](#) [↗ Finishes](#)

Kite Wave

Rectangle folding table

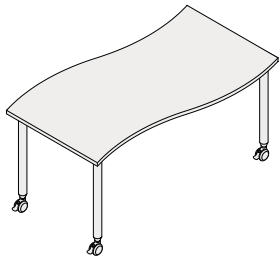

Height	Legs	Code	Tier 1	Tier 2	Tier 3
29"	Silver	KTW/86150/SS	1668	1856	2072
	Graphite	KTW/86150/SGR	1668	1856	2072
	Black	KTW/86150/SBL	1668	1856	2072
	White	KTW/86150/SWH	1794	1982	2198
	Eco	KTW/86150/ECO	1794	1982	2198
	Chrome	KTW/86150/SCH	1911	2099	2314
	Tapered Silver	KTW/86150/TSL	2092	2280	2495
36"	Silver	KTW/36/86150/SS	1966	2154	2369
	Graphite	KTW/36/86150/SGR	1966	2154	2369
	Black	KTW/36/86150/SBL	1966	2154	2369
	White	KTW/36/86150/SWH	2092	2280	2495
	Eco	KTW/36/86150/ECO	2092	2280	2495
41"	Silver	KTW/41/86150/SS	1966	2154	2369
	Graphite	KTW/41/86150/SGR	1966	2154	2369
	Black	KTW/41/86150/SBL	1966	2154	2369
	White	KTW/41/86150/SWH	2092	2280	2495
	Eco	KTW/41/86150/ECO	2092	2280	2495

Dimensions – Width 59" Depth 34"

Links

[← Contents](#) [↗ Finishes](#)

Kite Wave

Semi-circle folding table

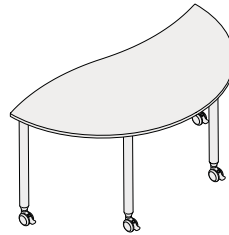

Height	Legs	Code	Tier 1	Tier 2	Tier 3
29"	Silver	KTSCW/80150/SS	1668	1856	2072
	Graphite	KTSCW/80150/SGR	1668	1856	2072
	Black	KTSCW/80150/SBL	1668	1856	2072
	White	KTSCW/80150/SWH	1794	1982	2198
	Eco	KTSCW/80150/ECO	1794	1982	2198
	Chrome	KTSCW/80150/SCH	1911	2099	2314
	Tapered Silver	KTSCW/80150/TSL	2092	2280	2495
36"	Silver	KTSCW/36/80150/SS	1966	2154	2369
	Graphite	KTSCW/36/80150/SGR	1966	2154	2369
	Black	KTSCW/36/80150/SBL	1966	2154	2369
	White	KTSCW/36/80150/SWH	2092	2280	2495
	Eco	KTSCW/36/80150/ECO	2092	2280	2495
41"	Silver	KTSCW/41/80150/SS	1966	2154	2256
	Graphite	KTSCW/41/80150/SGR	1966	2154	2256
	Black	KTSCW/41/80150/SBL	1966	2154	2256
	White	KTSCW/41/80150/SWH	2092	2280	2256
	Eco	KTSCW/41/80150/ECO	2092	2280	2256

Dimensions – Width 59" Depth 32"

Links

[← Contents](#) [↗ Finishes](#)

Height adjustable leg kit

For Kite® and Mini Mobile

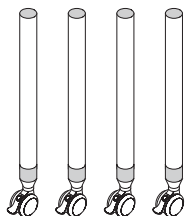

Legs	Size	Code	Price
Straight Silver	29-35"	HALKIT/SS	691
Straight Graphite	29-35"	HALKIT/SG	691
Straight Silver	25-31"	HALKIT/SS25-31	691

Glides

Feet for table legs

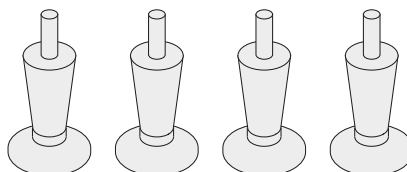

Code	Price
GLIDE	-104

Versatilis

Kite shape non-folding table

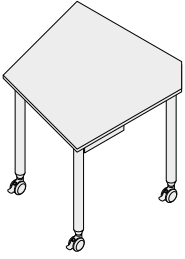

Height	Legs	Code	Tier 1	Tier 2	Tier 3
14"	Silver	VK/14/75/SS	1328	1516	1730
	Graphite	VK/14/75/SGR	1328	1516	1730
	Black	VK/14/75/SBL	1328	1516	1730
	White	VK/14/75/SWH	1454	1642	1856
	Eco	VK/14/75/ECO	1454	1642	1856
25"	Silver	VK/25/75/SS	1328	1516	1730
	Graphite	VK/25/75/SGR	1328	1516	1730
	Black	VK/25/75/SBL	1328	1516	1730
	White	VK/25/75/SWH	1454	1642	1856
	Eco	VK/25/75/ECO	1454	1642	1856
27"	Silver	VK/27/75/SS	1328	1516	1730
	Graphite	VK/27/75/SGR	1328	1516	1730
	Black	VK/27/75/SBL	1328	1516	1730
	White	VK/27/75/SWH	1454	1642	1856
	Eco	VK/27/75/ECO	1454	1642	1856
29"	Silver	VK/29/75/SS	1328	1516	1730
	Graphite	VK/29/75/SGR	1328	1516	1730
	Black	VK/29/75/SBL	1328	1516	1730
	White	VK/29/75/SWH	1454	1642	1856
	Eco	VK/29/75/ECO	1454	1642	1856
36"	Silver	VK/36/75/SS	1625	1812	2028
	Graphite	VK/36/75/SGR	1625	1812	2028
	Black	VK/36/75/SBL	1625	1812	2028
	White	VK/36/75/SWH	1751	1938	2154
	Eco	VK/36/75/ECO	1751	1938	2154
41"	Silver	VK/41/75/SS	1625	1812	2028
	Graphite	VK/41/75/SGR	1625	1812	2028
	Black	VK/41/75/SBL	1625	1812	2028
	White	VK/41/75/SWH	1751	1938	2154
	Eco	VK/41/75/ECO	1751	1938	2154

Dimensions – Width 29.5" Depth 29.5"

Links

[← Contents](#) [↗ Finishes](#)

Versatilis

750 Rectangle non-folding table (1500)

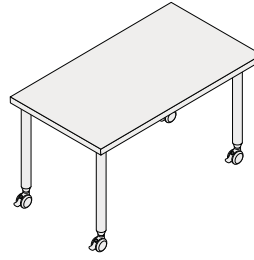

Height	Legs	Code	Tier 1	Tier 2	Tier 3
14"	Silver	VR/14/75150/SS	1168	1320	1547
	Graphite	VR/14/75150/SGR	1168	1320	1547
	Black	VR/14/75150/SBL	1168	1320	1547
	White	VR/14/75150/SWH	1294	1446	1673
	Eco	VR/14/75150/ECO	1294	1446	1673
25"	Silver	VR/25/75150/SS	1168	1320	1547
	Graphite	VR/25/75150/SGR	1168	1320	1547
	Black	VR/25/75150/SBL	1168	1320	1547
	White	VR/25/75150/SWH	1294	1446	1673
	Eco	VR/25/75150/ECO	1294	1446	1673
27"	Silver	VR/27/75150/SS	1168	1320	1547
	Graphite	VR/27/75150/SGR	1168	1320	1547
	Black	VR/27/75150/SBL	1168	1320	1547
	White	VR/27/75150/SWH	1294	1446	1673
	Eco	VR/27/75150/ECO	1294	1446	1673
29"	Silver	VR/75150/SS	1168	1320	1547
	Graphite	VR/75150/SGR	1168	1320	1547
	Black	VR/75150/SBL	1168	1320	1547
	White	VR/75150/SWH	1294	1446	1673
	Eco	VR/75150/ECO	1294	1446	1673
36"	Silver	VR/36/75150/SS	1465	1615	1844
	Graphite	VR/36/75150/SGR	1465	1615	1844
	Black	VR/36/75150/SBL	1465	1615	1844
	White	VR/36/75150/SWH	1591	1741	1970
	Eco	VR/36/75150/ECO	1591	1741	1970
41"	Silver	VR/41/75150/SS	1465	1615	1844
	Graphite	VR/41/75150/SGR	1465	1615	1844
	Black	VR/41/75150/SBL	1465	1615	1844
	White	VR/41/75150/SWH	1591	1741	1970
	Eco	VR/41/75150/ECO	1591	1741	1970

Dimensions – Width 59" Depth 29.5"

Links

[← Contents](#) [↗ Finishes](#)

Versatilis

750 Rectangle non-folding table (1300)

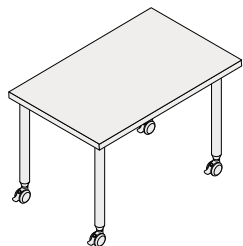

Height	Legs	Code	Tier 1	Tier 2	Tier 3
14"	Silver	VR/14/75130/SS	1166	1316	1541
	Graphite	VR/14/75130/SGR	1166	1316	1541
	Black	VR/14/75130/SBL	1166	1316	1541
	White	VR/14/75130/SWH	1292	1442	1667
	Eco	VR/14/75130/ECO	1292	1442	1667
25"	Silver	VR/25/75130/SS	1166	1316	1541
	Graphite	VR/25/75130/SGR	1166	1316	1541
	Black	VR/25/75130/SBL	1166	1316	1541
	White	VR/25/75130/SWH	1292	1442	1667
	Eco	VR/25/75130/ECO	1292	1442	1667
27"	Silver	VR/27/75130/SS	1166	1316	1541
	Graphite	VR/27/75130/SGR	1166	1316	1541
	Black	VR/27/75130/SBL	1166	1316	1541
	White	VR/27/75130/SWH	1292	1442	1667
	Eco	VR/27/75130/ECO	1292	1442	1667
29"	Silver	VR/75130/SS	1166	1316	1541
	Graphite	VR/75130/SGR	1166	1316	1541
	Black	VR/75130/SBL	1166	1316	1541
	White	VR/75130/SWH	1292	1442	1667
	Eco	VR/75130/ECO	1292	1442	1667
36"	Silver	VR/36/75130/SS	1463	1613	1839
	Graphite	VR/36/75130/SGR	1463	1613	1839
	Black	VR/36/75130/SBL	1463	1613	1839
	White	VR/36/75130/SWH	1589	1739	1965
	Eco	VR/36/75130/ECO	1589	1739	1965
41"	Silver	VR/41/75130/SS	1463	1613	1839
	Graphite	VR/41/75130/SGR	1463	1613	1839
	Black	VR/41/75130/SBL	1463	1613	1839
	White	VR/41/75130/SWH	1589	1739	1965
	Eco	VR/41/75130/ECO	1589	1739	1965

Dimensions – Width 51" Depth 29.5"

Links

[← Contents](#) [↗ Finishes](#)

Versatilis

750 Square non-folding table

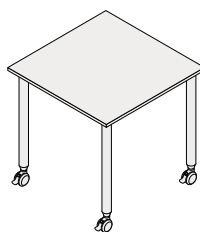

Height	Legs	Code	Tier 1	Tier 2	Tier 3
14"	Silver	VS/14/7575/SS	930	1065	1272
	Graphite	VS/14/7575/SGR	930	1065	1272
	Black	VS/14/7575/SBL	930	1065	1272
	White	VS/14/7575/SWH	1056	1191	1398
	Eco	VS/14/7575/ECO	1056	1191	1398
25"	Silver	VS/25/7575/SS	930	1065	1272
	Graphite	VS/25/7575/SGR	930	1065	1272
	Black	VS/25/7575/SBL	930	1065	1272
	White	VS/25/7575/SWH	1056	1191	1398
	Eco	VS/25/7575/ECO	1056	1191	1398
27"	Silver	VS/27/7575/SS	930	1065	1272
	Graphite	VS/27/7575/SGR	930	1065	1272
	Black	VS/27/7575/SBL	930	1065	1272
	White	VS/27/7575/SWH	1056	1191	1398
	Eco	VS/27/7575/ECO	1056	1191	1398
29"	Silver	VS/7575/SS	930	1065	1272
	Graphite	VS/7575/SGR	930	1065	1272
	Black	VS/7575/SBL	930	1065	1272
	White	VS/7575/SWH	1056	1191	1398
	Eco	VS/7575/ECO	1056	1191	1398
36"	Silver	VS/36/7575/SS	1227	1362	1569
	Graphite	VS/36/7575/SGR	1227	1362	1569
	Black	VS/36/7575/SBL	1227	1362	1569
	White	VS/36/7575/SWH	1353	1488	1695
	Eco	VS/36/7575/ECO	1353	1488	1695
41"	Silver	VS/41/7575/SS	1227	1362	1569
	Graphite	VS/41/7575/SGR	1227	1362	1569
	Black	VS/41/7575/SBL	1227	1362	1569
	White	VS/41/7575/SWH	1353	1488	1695
	Eco	VS/41/7575/ECO	1353	1488	1695

Dimensions – Width 29.5" Depth 29.5"

Links

[← Contents](#) [↗ Finishes](#)

Versatilis

650 Rectangle non-folding table (1300)

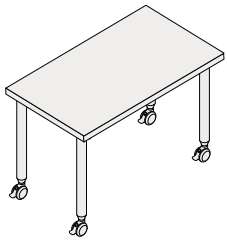

Height	Legs	Code	Tier 1	Tier 2	Tier 3
14"	Silver	VR/14/65130/SS	1157	1310	1541
	Graphite	VR/14/65130/SGR	1157	1310	1541
	Black	VR/14/65130/SBL	1157	1310	1541
	White	VR/14/65130/SWH	1283	1436	1667
	Eco	VR/14/65130/ECO	1283	1436	1667
25"	Silver	VR/25/65130/SS	1157	1310	1541
	Graphite	VR/25/65130/SGR	1157	1310	1541
	Black	VR/25/65130/SBL	1157	1310	1541
	White	VR/25/65130/SWH	1283	1436	1667
	Eco	VR/25/65130/ECO	1283	1436	1667
27"	Silver	VR/27/65130/SS	1157	1310	1541
	Graphite	VR/27/65130/SGR	1157	1310	1541
	Black	VR/27/65130/SBL	1157	1310	1541
	White	VR/27/65130/SWH	1283	1436	1667
	Eco	VR/27/65130/ECO	1283	1436	1667
29"	Silver	VR/65130/SS	1157	1310	1541
	Graphite	VR/65130/SGR	1157	1310	1541
	Black	VR/65130/SBL	1157	1310	1541
	White	VR/65130/SWH	1283	1436	1667
	Eco	VR/65130/ECO	1283	1436	1667
36"	Silver	VR/36/65130/SS	1454	1608	1839
	Graphite	VR/36/65130/SGR	1454	1608	1839
	Black	VR/36/65130/SBL	1454	1608	1839
	White	VR/36/65130/SWH	1580	1734	1965
	Eco	VR/36/65130/ECO	1580	1734	1965
41"	Silver	VR/41/65130/SS	1454	1608	1839
	Graphite	VR/41/65130/SGR	1454	1608	1839
	Black	VR/41/65130/SBL	1454	1608	1839
	White	VR/41/65130/SWH	1580	1734	1965
	Eco	VR/41/65130/ECO	1580	1734	1965

Dimensions – Width 51" Depth 25.5"

Links

[← Contents](#) [↗ Finishes](#)

Versatilis

650 Rectangle non-folding table (1500)

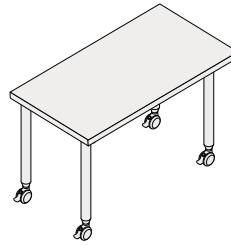

Height	Legs	Code	Tier 1	Tier 2	Tier 3
14"	Silver	VR/14/65150/SS	1166	1316	1541
	Graphite	VR/14/65150/SGR	1166	1316	1541
	Black	VR/14/65150/SBL	1166	1316	1541
	White	VR/14/65150/SWH	1292	1442	1667
	Eco	VR/14/65150/ECO	1292	1442	1667
25"	Silver	VR/25/65150/SS	1166	1316	1541
	Graphite	VR/25/65150/SGR	1166	1316	1541
	Black	VR/25/65150/SBL	1166	1316	1541
	White	VR/25/65150/SWH	1292	1442	1667
	Eco	VR/25/65150/ECO	1292	1442	1667
27"	Silver	VR/27/65150/SS	1166	1316	1541
	Graphite	VR/27/65150/SGR	1166	1316	1541
	Black	VR/27/65150/SBL	1166	1316	1541
	White	VR/27/65150/SWH	1292	1442	1667
	Eco	VR/27/65150/ECO	1292	1442	1667
29"	Silver	VR/65150/SS	1166	1316	1541
	Graphite	VR/65150/SGR	1166	1316	1541
	Black	VR/65150/SBL	1166	1316	1541
	White	VR/65150/SWH	1292	1442	1667
	Eco	VR/65150/ECO	1292	1442	1667
36"	Silver	VR/36/65150/SS	1463	1613	1839
	Graphite	VR/36/65150/SGR	1463	1613	1839
	Black	VR/36/65150/SBL	1463	1613	1839
	White	VR/36/65150/SWH	1589	1739	1965
	Eco	VR/36/65150/ECO	1589	1739	1965
41"	Silver	VR/41/65150/SS	1463	1613	1839
	Graphite	VR/41/65150/SGR	1463	1613	1839
	Black	VR/41/65150/SBL	1463	1613	1839
	White	VR/41/65150/SWH	1589	1739	1965
	Eco	VR/41/65150/ECO	1589	1739	1965

Dimensions – Width 59" Depth 25.5"

Links

[← Contents](#) [↗ Finishes](#)

Versatilis

1050 Circle non-folding table

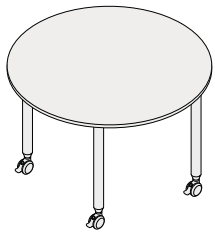

Height	Legs	Code	Tier 1	Tier 2	Tier 3
14"	Silver	VFC/14/105/SS	1160	1305	1521
	Graphite	VFC/14/105/SGR	1160	1305	1521
	Black	VFC/14/105/SBL	1160	1305	1521
	White	VFC/14/105/SWH	1286	1431	1647
	Eco	VFC/14/105/ECO	1286	1431	1647
25"	Silver	VFC/25/105/SS	1160	1305	1521
	Graphite	VFC/25/105/SGR	1160	1305	1521
	Black	VFC/25/105/SBL	1160	1305	1521
	White	VFC/25/105/SWH	1286	1431	1647
	Eco	VFC/25/105/ECO	1286	1431	1647
27"	Silver	VFC/27/105/SS	1160	1305	1521
	Graphite	VFC/27/105/SGR	1160	1305	1521
	Black	VFC/27/105/SBL	1160	1305	1521
	White	VFC/27/105/SWH	1286	1431	1647
	Eco	VFC/27/105/ECO	1286	1431	1647
29"	Silver	VFC/105/SS	1160	1305	1521
	Graphite	VFC/105/SGR	1160	1305	1521
	Black	VFC/105/SBL	1160	1305	1521
	White	VFC/105/SWH	1286	1431	1647
	Eco	VFC/105/ECO	1286	1431	1647
36"	Silver	VFC/36/105/SS	1456	1602	1819
	Graphite	VFC/36/105/SGR	1456	1602	1819
	Black	VFC/36/105/SBL	1456	1602	1819
	White	VFC/36/105/SWH	1582	1728	1945
	Eco	VFC/36/105/ECO	1582	1728	1945
41"	Silver	VFC/41/105/SS	1456	1602	1819
	Graphite	VFC/41/105/SGR	1456	1602	1819
	Black	VFC/41/105/SBL	1456	1602	1819
	White	VFC/41/105/SWH	1582	1728	1945
	Eco	VFC/41/105/ECO	1582	1728	1945

Dimensions – Width 41.5" Depth 41.5"

Links

[← Contents](#) [↗ Finishes](#)

Versatilis

850 Circle non-folding table

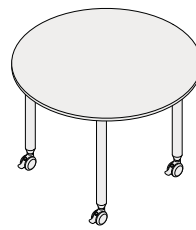

Height	Legs	Code	Tier 1	Tier 2	Tier 3
14"	Silver	VFC/14/85/SS	1027	1153	1342
	Graphite	VFC/14/85/SGR	1027	1153	1342
	Black	VFC/14/85/SBL	1027	1153	1342
	White	VFC/14/85/SWH	1153	1279	1468
	Eco	VFC/14/85/ECO	1153	1279	1468
25"	Silver	VFC/25/85/SS	1027	1153	1342
	Graphite	VFC/25/85/SGR	1027	1153	1342
	Black	VFC/25/85/SBL	1027	1153	1342
	White	VFC/25/85/SWH	1153	1279	1468
	Eco	VFC/25/85/ECO	1153	1279	1468
27"	Silver	VFC/27/85/SS	1027	1153	1342
	Graphite	VFC/27/85/SGR	1027	1153	1342
	Black	VFC/27/85/SBL	1027	1153	1342
	White	VFC/27/85/SWH	1153	1279	1468
	Eco	VFC/27/85/ECO	1153	1279	1468
29"	Silver	VFC/85/SS	1027	1153	1342
	Graphite	VFC/85/SGR	1027	1153	1342
	Black	VFC/85/SBL	1027	1153	1342
	White	VFC/85/SWH	1153	1279	1468
	Eco	VFC/85/ECO	1153	1279	1468
36"	Silver	VFC/36/85/SS	1324	1450	1638
	Graphite	VFC/36/85/SGR	1324	1450	1638
	Black	VFC/36/85/SBL	1324	1450	1638
	White	VFC/36/85/SWH	1450	1576	1764
	Eco	VFC/36/85/ECO	1450	1576	1764
41"	Silver	VFC/41/7575/SS	1324	1450	1638
	Graphite	VFC/41/7575/SGR	1324	1450	1638
	Black	VFC/41/7575/SBL	1324	1450	1638
	White	VFC/41/7575/SWH	1450	1576	1764
	Eco	VFC/41/7575/ECO	1450	1576	1764

Dimensions – Width 33.5" Depth 33.5"

Links

[← Contents](#) [↗ Finishes](#)

Versatilis

1050 Crescent non-folding table

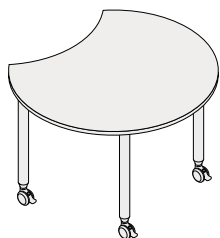

Height	Legs	Code	Tier 1	Tier 2	Tier 3
14"	Silver	VCT/14/105/SS	1160	1305	1521
	Graphite	VCT/14/105/SGR	1160	1305	1521
	Black	VCT/14/105/SBL	1160	1305	1521
	White	VCT/14/105/SWH	1286	1431	1647
	Eco	VCT/14/105/ECO	1286	1431	1647
25"	Silver	VCT/25/105/SS	1160	1305	1521
	Graphite	VCT/25/105/SGR	1160	1305	1521
	Black	VCT/25/105/SBL	1160	1305	1521
	White	VCT/25/105/SWH	1286	1431	1647
	Eco	VCT/25/105/ECO	1286	1431	1647
27"	Silver	VCT/27/105/SS	1160	1305	1521
	Graphite	VCT/27/105/SGR	1160	1305	1521
	Black	VCT/27/105/SBL	1160	1305	1521
	White	VCT/27/105/SWH	1286	1431	1647
	Eco	VCT/27/105/ECO	1286	1431	1647
29"	Silver	VCT/105/SS	1160	1305	1521
	Graphite	VCT/105/SGR	1160	1305	1521
	Black	VCT/105/SBL	1160	1305	1521
	White	VCT/105/SWH	1286	1431	1647
	Eco	VCT/105/ECO	1286	1431	1647
36"	Silver	VCT/36/105/SS	1456	1602	1819
	Graphite	VCT/36/105/SGR	1456	1602	1819
	Black	VCT/36/105/SBL	1456	1602	1819
	White	VCT/36/105/SWH	1582	1728	1945
	Eco	VCT/36/105/ECO	1582	1728	1945
41"	Silver	VCT/41/105/SS	1456	1602	1819
	Graphite	VCT/41/105/SGR	1456	1602	1819
	Black	VCT/41/105/SBL	1456	1602	1819
	White	VCT/41/105/SWH	1582	1728	1945
	Eco	VCT/41/105/ECO	1582	1728	1945

Dimensions – Width 41.5" Depth 37"

Links

[← Contents](#) [↗ Finishes](#)

Versatilis

850 Crescent non-folding table

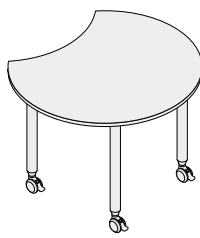

Height	Legs	Code	Tier 1	Tier 2	Tier 3
14"	Silver	VCT/14/85/SS	1027	1153	1342
	Graphite	VCT/14/85/SGR	1027	1153	1342
	Black	VCT/14/85/SBL	1027	1153	1342
	White	VCT/14/85/SWH	1153	1279	1468
	Eco	VCT/14/85/ECO	1153	1279	1468
25"	Silver	VCT/25/85/SS	1027	1153	1342
	Graphite	VCT/25/85/SGR	1027	1153	1342
	Black	VCT/25/85/SBL	1027	1153	1342
	White	VCT/25/85/SWH	1153	1279	1468
	Eco	VCT/25/85/ECO	1153	1279	1468
27"	Silver	VCT/27/85/SS	1027	1153	1342
	Graphite	VCT/27/85/SGR	1027	1153	1342
	Black	VCT/27/85/SBL	1027	1153	1342
	White	VCT/27/85/SWH	1153	1279	1468
	Eco	VCT/27/85/ECO	1153	1279	1468
29"	Silver	VCT/85/SS	1027	1153	1342
	Graphite	VCT/85/SGR	1027	1153	1342
	Black	VCT/85/SBL	1027	1153	1342
	White	VCT/85/SWH	1153	1279	1468
	Eco	VCT/85/ECO	1153	1279	1468
36"	Silver	VCT/36/85/SS	1324	1450	1638
	Graphite	VCT/36/85/SGR	1324	1450	1638
	Black	VCT/36/85/SBL	1324	1450	1638
	White	VCT/36/85/SWH	1450	1576	1764
	Eco	VCT/36/85/ECO	1450	1576	1764
41"	Silver	VCT/41/85/SS	1324	1450	1638
	Graphite	VCT/41/85/SGR	1324	1450	1638
	Black	VCT/41/85/SBL	1324	1450	1638
	White	VCT/41/85/SWH	1450	1576	1764
	Eco	VCT/41/85/ECO	1450	1576	1764

Dimensions – Width 33.5" Depth 30"

Links

[← Contents](#) [↗ Finishes](#)

Versatilis

Curve non-folding table

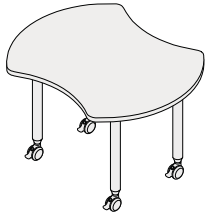

Height	Legs	Code	Tier 1	Tier 2	Tier 3
14"	Silver	VCV/14/SS	1196	1328	1485
	Graphite	VCV/14/SGR	1196	1328	1485
	Black	VCV/14/SBL	1196	1328	1485
	White	VCV/14/SWH	1322	1454	1611
	Eco	VCV/14/ECO	1322	1454	1611
25"	Silver	VCV/25/SS	1196	1328	1485
	Graphite	VCV/25/SGR	1196	1328	1485
	Black	VCV/25/SBL	1196	1328	1485
	White	VCV/25/SWH	1322	1454	1611
	Eco	VCV/25/ECO	1322	1454	1611
27"	Silver	VCV/27/SS	1196	1328	1485
	Graphite	VCV/27/SGR	1196	1328	1485
	Black	VCV/27/SBL	1196	1328	1485
	White	VCV/27/SWH	1322	1454	1611
	Eco	VCV/27/ECO	1322	1454	1611
29"	Silver	VCV/SS	1196	1328	1485
	Graphite	VCV/SGR	1196	1328	1485
	Black	VCV/SBL	1196	1328	1485
	White	VCV/SWH	1322	1454	1611
	Eco	VCV/ECO	1322	1454	1611
36"	Silver	VCV/36/SS	1493	1625	1781
	Graphite	VCV/36/SGR	1493	1625	1781
	Black	VCV/36/SBL	1493	1625	1781
	White	VCV/36/SWH	1619	1751	1907
	Eco	VCV/36/ECO	1619	1751	1907
41"	Silver	VCV/41/SS	1493	1625	1781
	Graphite	VCV/41/SGR	1493	1625	1781
	Black	VCV/41/SBL	1493	1625	1781
	White	VCV/41/SWH	1619	1751	1907
	Eco	VCV/41/ECO	1619	1751	1907

Dimensions – Width 39.5" Depth 32"

Links

[← Contents](#) [↗ Finishes](#)

Versatilis

1500 Semi-circle non-folding table

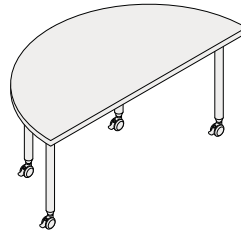

Height	Legs	Code	Tier 1	Tier 2	Tier 3
14"	Silver	VSC/14/75150/SS	1317	1505	1720
	Graphite	VSC/14/75150/SGR	1317	1505	1720
	Black	VSC/14/75150/SBL	1317	1505	1720
	White	VSC/14/75150/SWH	1443	1631	1846
	Eco	VSC/14/75150/ECO	1443	1631	1846
25"	Silver	VSC/25/75150/SS	1317	1505	1720
	Graphite	VSC/25/75150/SGR	1317	1505	1720
	Black	VSC/25/75150/SBL	1317	1505	1720
	White	VSC/25/75150/SWH	1443	1631	1846
	Eco	VSC/25/75150/ECO	1443	1631	1846
27"	Silver	VSC/27/75150/SS	1317	1505	1720
	Graphite	VSC/27/75150/SGR	1317	1505	1720
	Black	VSC/27/75150/SBL	1317	1505	1720
	White	VSC/27/75150/SWH	1443	1631	1846
	Eco	VSC/27/75150/ECO	1443	1631	1846
29"	Silver	VSC/75150/SS	1317	1505	1720
	Graphite	VSC/75150/SGR	1317	1505	1720
	Black	VSC/75150/SBL	1317	1505	1720
	White	VSC/75150/SWH	1443	1631	1846
	Eco	VSC/75150/ECO	1443	1631	1846
36"	Silver	VSC/36/75150/SS	1614	1802	2017
	Graphite	VSC/36/75150/SGR	1614	1802	2017
	Black	VSC/36/75150/SBL	1614	1802	2017
	White	VSC/36/75150/SWH	1740	1928	2143
	Eco	VSC/36/75150/ECO	1740	1928	2143
41"	Silver	VSC/41/75150/SS	1614	1802	2017
	Graphite	VSC/41/75150/SGR	1614	1802	2017
	Black	VSC/41/75150/SBL	1614	1802	2017
	White	VSC/41/75150/SWH	1740	1928	2143
	Eco	VSC/41/75150/ECO	1740	1928	2143

Dimensions – Width 59" Depth 29.5"

Links

[← Contents](#) [↗ Finishes](#)

Versatilis

Wave Semi-circle non-folding table

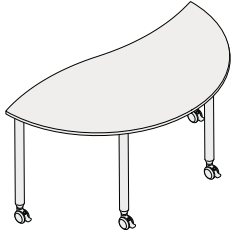

Height	Legs	Code	Tier 1	Tier 2	Tier 3
14"	Silver	VSCW/14/SS	1317	1505	1720
	Graphite	VSCW/14/SGR	1317	1505	1720
	Black	VSCW/14/SBL	1317	1505	1720
	White	VSCW/14/SWH	1443	1631	1846
	Eco	VSCW/14/ECO	1443	1631	1846
25"	Silver	VSCW/25/SS	1317	1505	1720
	Graphite	VSCW/25/SGR	1317	1505	1720
	Black	VSCW/25/SBL	1317	1505	1720
	White	VSCW/25/SWH	1443	1631	1846
	Eco	VSCW/25/ECO	1443	1631	1846
27"	Silver	VSCW/27/SS	1317	1505	1720
	Graphite	VSCW/27/SGR	1317	1505	1720
	Black	VSCW/27/SBL	1317	1505	1720
	White	VSCW/27/SWH	1443	1631	1846
	Eco	VSCW/27/ECO	1443	1631	1846
29"	Silver	VSCW/SS	1317	1505	1720
	Graphite	VSCW/SGR	1317	1505	1720
	Black	VSCW/SBL	1317	1505	1720
	White	VSCW/SWH	1443	1631	1846
	Eco	VSCW/ECO	1443	1631	1846
36"	Silver	VSCW/36/SS	1614	1802	2017
	Graphite	VSCW/36/SGR	1614	1802	2017
	Black	VSCW/36/SBL	1614	1802	2017
	White	VSCW/36/SWH	1740	1928	2143
	Eco	VSCW/36/ECO	1740	1928	2143
41"	Silver	VSCW/41/SS	1614	1802	2017
	Graphite	VSCW/41/SGR	1614	1802	2017
	Black	VSCW/41/SBL	1614	1802	2017
	White	VSCW/41/SWH	1740	1928	2143
	Eco	VSCW/41/ECO	1740	1928	2143

Dimensions – Width 59" Depth 32"

Links

[← Contents](#) [↗ Finishes](#)

Versatilis

Wave Rectangle non-folding table

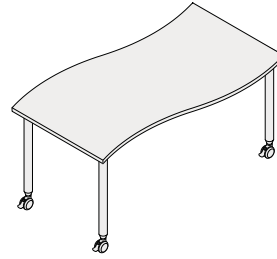

Height	Legs	Code	Tier 1	Tier 2	Tier 3
14"	Silver	VW/14/SS	1328	1423	1659
	Graphite	VW/14/SGR	1328	1423	1659
	Black	VW/14/SBL	1328	1423	1659
	White	VW/14/SWH	1454	1549	1785
	Eco	VW/14/ECO	1454	1549	1785
25"	Silver	VW/25/SS	1328	1423	1659
	Graphite	VW/25/SGR	1328	1423	1659
	Black	VW/25/SBL	1328	1423	1659
	White	VW/25/SWH	1454	1549	1785
	Eco	VW/25/ECO	1454	1549	1785
27"	Silver	VW/27/SS	1328	1423	1659
	Graphite	VW/27/SGR	1328	1423	1659
	Black	VW/27/SBL	1328	1423	1659
	White	VW/27/SWH	1454	1549	1785
	Eco	VW/27/ECO	1454	1549	1785
29"	Silver	VW/SS	1328	1423	1659
	Graphite	VW/SGR	1328	1423	1659
	Black	VW/SBL	1328	1423	1659
	White	VW/SWH	1454	1549	1785
	Eco	VW/ECO	1454	1549	1785
36"	Silver	VW/36/SS	1625	1720	1956
	Graphite	VW/36/SGR	1625	1720	1956
	Black	VW/36/SBL	1625	1720	1956
	White	VW/36/SWH	1751	1846	2082
	Eco	VW/36/ECO	1751	1846	2082
41"	Silver	VW/41/SS	1625	1720	1956
	Graphite	VW/41/SGR	1625	1720	1956
	Black	VW/41/SBL	1625	1720	1956
	White	VW/41/SWH	1751	1846	2082
	Eco	VW/41/ECO	1751	1846	2082

Dimensions – Width 59" Depth 34"

Links

[← Contents](#) [↗ Finishes](#)

Versatilis

Hexel non-folding table

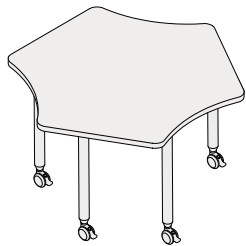

Height	Legs	Code	Tier 1	Tier 2	Tier 3
14"	Silver	VHEX/14/SS	1813	1946	2292
	Graphite	VHEX/14/SGR	1813	1946	2292
	Black	VHEX/14/SBL	1813	1946	2292
	White	VHEX/14/SWH	1939	2072	2418
	Eco	VHEX/14/ECO	1939	2072	2418
25"	Silver	VHEX/25/SS	1813	1946	2292
	Graphite	VHEX/25/SGR	1813	1946	2292
	Black	VHEX/25/SBL	1813	1946	2292
	White	VHEX/25/SWH	1939	2072	2418
	Eco	VHEX/25/ECO	1939	2072	2418
27"	Silver	VHEX/27/SS	1813	1946	2292
	Graphite	VHEX/27/SGR	1813	1946	2292
	Black	VHEX/27/SBL	1813	1946	2292
	White	VHEX/27/SWH	1939	2072	2418
	Eco	VHEX/27/ECO	1939	2072	2418
29"	Silver	VHEX/SS	1813	1946	2292
	Graphite	VHEX/SGR	1813	1946	2292
	Black	VHEX/SBL	1813	1946	2292
	White	VHEX/SWH	1939	2072	2418
	Eco	VHEX/ECO	1939	2072	2418
36"	Silver	VHEX/36/SS	2258	2392	2737
	Graphite	VHEX/36/SGR	2258	2392	2737
	Black	VHEX/36/SBL	2258	2392	2737
	White	VHEX/36/SWH	2384	2518	2863
	Eco	VHEX/36/ECO	2384	2518	2863
41"	Silver	VHEX/41/SS	2258	2392	2737
	Graphite	VHEX/41/SGR	2258	2392	2737
	Black	VHEX/41/SBL	2258	2392	2737
	White	VHEX/41/SWH	2384	2518	2863
	Eco	VHEX/41/ECO	2384	2518	2863

Dimensions – Width 54.5" Depth 48"

Links

[← Contents](#) [↗ Finishes](#)

Versatilis

Tri non-folding table

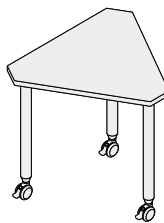

Height	Legs	Code	Tier 1	Tier 2	Tier 3
14"	Silver	VTRI/14/SS	891	929	1193
	Graphite	VTRI/14/SGR	891	929	1193
	Black	VTRI/14/SBL	891	929	1193
	White	VTRI/14/SWH	1017	1055	1319
	Eco	VTRI/14/ECO	1017	1055	1319
25"	Silver	VTRI/25/SS	891	929	1193
	Graphite	VTRI/25/SGR	891	929	1193
	Black	VTRI/25/SBL	891	929	1193
	White	VTRI/25/SWH	1017	1055	1319
	Eco	VTRI/25/ECO	1017	1055	1319
27"	Silver	VTRI/27/SS	891	929	1193
	Graphite	VTRI/27/SGR	891	929	1193
	Black	VTRI/27/SBL	891	929	1193
	White	VTRI/27/SWH	1017	1055	1319
	Eco	VTRI/27/ECO	1017	1055	1319
29"	Silver	VTRI/SS	891	929	1193
	Graphite	VTRI/SGR	891	929	1193
	Black	VTRI/SBL	891	929	1193
	White	VTRI/SWH	1017	1055	1319
	Eco	VTRI/ECO	1017	1055	1319
36"	Silver	VTRI/36/SS	1115	1152	1416
	Graphite	VTRI/36/SGR	1115	1152	1416
	Black	VTRI/36/SBL	1115	1152	1416
	White	VTRI/36/SWH	1241	1278	1542
	Eco	VTRI/36/ECO	1241	1278	1542
41"	Silver	VTRI/41/SS	1115	1152	1416
	Graphite	VTRI/41/SGR	1115	1152	1416
	Black	VTRI/41/SBL	1115	1152	1416
	White	VTRI/41/SWH	1241	1278	1542
	Eco	VTRI/41/ECO	1241	1278	1542

Dimensions – Width 28" Depth 32"

Links

[← Contents](#) [↗ Finishes](#)

Versatilis

Tulsa Plec non-folding table

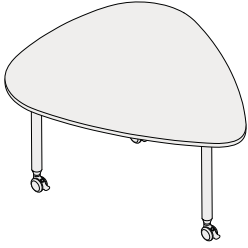

Height	Legs	Code	Tier 1	Tier 2	Tier 3
14"	Silver	VPIC/14/SS	1305	1398	1739
	Graphite	VPIC/14/SGR	1305	1398	1739
	Black	VPIC/14/SBL	1305	1398	1739
	White	VPIC/14/SWH	1431	1524	1865
	Eco	VPIC/14/ECO	1431	1524	1865
25"	Silver	VPIC/25/SS	1305	1398	1739
	Graphite	VPIC/25/SGR	1305	1398	1739
	Black	VPIC/25/SBL	1305	1398	1739
	White	VPIC/25/SWH	1431	1524	1865
	Eco	VPIC/25/ECO	1431	1524	1865
27"	Silver	VPIC/27/SS	1305	1398	1739
	Graphite	VPIC/27/SGR	1305	1398	1739
	Black	VPIC/27/SBL	1305	1398	1739
	White	VPIC/27/SWH	1431	1524	1865
	Eco	VPIC/27/ECO	1431	1524	1865
29"	Silver	VPIC/SS	1305	1398	1739
	Graphite	VPIC/SGR	1305	1398	1739
	Black	VPIC/SBL	1305	1398	1739
	White	VPIC/SWH	1431	1524	1865
	Eco	VPIC/ECO	1431	1524	1865
36"	Silver	VPIC/36/SS	1529	1620	1961
	Graphite	VPIC/36/SGR	1529	1620	1961
	Black	VPIC/36/SBL	1529	1620	1961
	White	VPIC/36/SWH	1655	1746	2087
	Eco	VPIC/36/ECO	1655	1746	2087
41"	Silver	VPIC/41/SS	1529	1620	1961
	Graphite	VPIC/41/SGR	1529	1620	1961
	Black	VPIC/41/SBL	1529	1620	1961
	White	VPIC/41/SWH	1655	1746	2087
	Eco	VPIC/41/ECO	1655	1746	2087

Dimensions – Width 48" Depth 53.5"

Links

[← Contents](#) [↗ Finishes](#)

Versatilis

Petal non-folding table

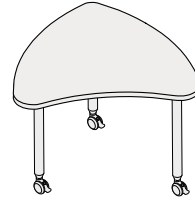

Height	Legs	Code	Tier 1	Tier 2	Tier 3
14"	Silver	VPL/14/SS	941	1036	1326
	Graphite	VPL/14/SGR	941	1036	1326
	Black	VPL/14/SBL	941	1036	1326
	White	VPL/14/SWH	1067	1162	1452
	Eco	VPL/14/ECO	1067	1162	1452
25"	Silver	VPL/25/SS	941	1036	1326
	Graphite	VPL/25/SGR	941	1036	1326
	Black	VPL/25/SBL	941	1036	1326
	White	VPL/25/SWH	1067	1162	1452
	Eco	VPL/25/ECO	1067	1162	1452
27"	Silver	VPL/27/SS	941	1036	1326
	Graphite	VPL/27/SGR	941	1036	1326
	Black	VPL/27/SBL	941	1036	1326
	White	VPL/27/SWH	1067	1162	1452
	Eco	VPL/27/ECO	1067	1162	1452
29"	Silver	VPL/SS	941	1036	1326
	Graphite	VPL/SGR	941	1036	1326
	Black	VPL/SBL	941	1036	1326
	White	VPL/SWH	1067	1162	1452
	Eco	VPL/ECO	1067	1162	1452
36"	Silver	VPL/36/SS	1164	1260	1549
	Graphite	VPL/36/SGR	1164	1260	1549
	Black	VPL/36/SBL	1164	1260	1549
	White	VPL/36/SWH	1290	1386	1675
	Eco	VPL/36/ECO	1290	1386	1675
41"	Silver	VPL/41/SS	1164	1260	1549
	Graphite	VPL/41/SGR	1164	1260	1549
	Black	VPL/41/SBL	1164	1260	1549
	White	VPL/41/SWH	1290	1386	1675
	Eco	VPL/41/ECO	1290	1386	1675

Dimensions – Width 33" Depth 33"

Links

[← Contents](#) [↗ Finishes](#)

Versatilis

Edge non-folding table

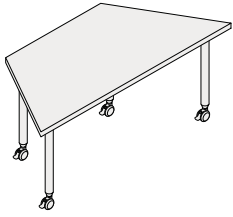

Height	Legs	Code	Tier 1	Tier 2	Tier 3
14"	Silver	VDG/14/SS	1243	1393	1490
	Graphite	VDG/14/SGR	1243	1393	1490
	Black	VDG/14/SBL	1243	1393	1490
	White	VDG/14/SWH	1369	1519	1616
	Eco	VDG/14/ECO	1369	1519	1616
25"	Silver	VDG/25/SS	1243	1393	1490
	Graphite	VDG/25/SGR	1243	1393	1490
	Black	VDG/25/SBL	1243	1393	1490
	White	VDG/25/SWH	1369	1519	1616
	Eco	VDG/25/ECO	1369	1519	1616
27"	Silver	VDG/27/SS	1243	1393	1490
	Graphite	VDG/27/SGR	1243	1393	1490
	Black	VDG/27/SBL	1243	1393	1490
	White	VDG/27/SWH	1369	1519	1616
	Eco	VDG/27/ECO	1369	1519	1616
29"	Silver	VDG/SS	1243	1393	1490
	Graphite	VDG/SGR	1243	1393	1490
	Black	VDG/SBL	1243	1393	1490
	White	VDG/SWH	1369	1519	1616
	Eco	VDG/ECO	1369	1519	1616
36"	Silver	VDG/36/SS	1539	1691	1786
	Graphite	VDG/36/SGR	1539	1691	1786
	Black	VDG/36/SBL	1539	1691	1786
	White	VDG/36/SWH	1665	1817	1912
	Eco	VDG/36/ECO	1665	1817	1912
41"	Silver	VDG/41/SS	1539	1691	1786
	Graphite	VDG/41/SGR	1539	1691	1786
	Black	VDG/41/SBL	1539	1691	1786
	White	VDG/41/SWH	1665	1817	1912
	Eco	VDG/41/ECO	1665	1817	1912

Dimensions – Width 59" Depth 26"

Links

[← Contents](#) [↗ Finishes](#)

Versatilis

Thin Rectangle non-folding table

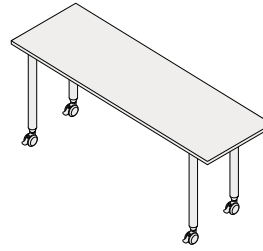

Height	Legs	Code	Tier 1	Tier 2	Tier 3
14"	Silver	VR/14/50150/SS	1303	1347	1604
	Graphite	VR/14/50150/SGR	1303	1347	1604
	Black	VR/14/50150/SBL	1303	1347	1604
	White	VR/14/50150/SWH	1429	1473	1730
	Eco	VR/14/50150/ECO	1429	1473	1730
25"	Silver	VR/25/50150/SS	1303	1347	1604
	Graphite	VR/25/50150/SGR	1303	1347	1604
	Black	VR/25/50150/SBL	1303	1347	1604
	White	VR/25/50150/SWH	1429	1473	1730
	Eco	VR/25/50150/ECO	1429	1473	1730
27"	Silver	VR/27/50150/SS	1303	1347	1604
	Graphite	VR/27/50150/SGR	1303	1347	1604
	Black	VR/27/50150/SBL	1303	1347	1604
	White	VR/27/50150/SWH	1429	1473	1730
	Eco	VR/27/50150/ECO	1429	1473	1730
29"	Silver	VR/50150/SS	1303	1347	1604
	Graphite	VR/50150/SGR	1303	1347	1604
	Black	VR/50150/SBL	1303	1347	1604
	White	VR/50150/SWH	1429	1473	1730
	Eco	VR/50150/ECO	1429	1473	1730
36"	Silver	VR/36/50150/SS	1600	1644	1902
	Graphite	VR/36/50150/SGR	1600	1644	1902
	Black	VR/36/50150/SBL	1600	1644	1902
	White	VR/36/50150/SWH	1726	1770	2028
	Eco	VR/36/50150/ECO	1726	1770	2028
41"	Silver	VR/41/50150/SS	1600	1644	1902
	Graphite	VR/41/50150/SGR	1600	1644	1902
	Black	VR/41/50150/SBL	1600	1644	1902
	White	VR/41/50150/SWH	1726	1770	2028
	Eco	VR/41/50150/ECO	1726	1770	2028

Dimensions – Width 59" Depth 20"

Links

[← Contents](#) [↗ Finishes](#)

Versatilis

Spade non-folding table

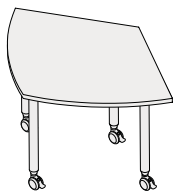

Height	Legs	Code	Tier 1	Tier 2	Tier 3
14"	Silver	VPD/14/SS	1328	1369	1610
	Graphite	VPD/14/SGR	1328	1369	1610
	Black	VPD/14/SBL	1328	1369	1610
	White	VPD/14/SWH	1454	1495	1736
	Eco	VPD/14/ECO	1454	1495	1736
25"	Silver	VPD/25/SS	1328	1369	1610
	Graphite	VPD/25/SGR	1328	1369	1610
	Black	VPD/25/SBL	1328	1369	1610
	White	VPD/25/SWH	1454	1495	1736
	Eco	VPD/25/ECO	1454	1495	1736
27"	Silver	VPD/27/SS	1328	1369	1610
	Graphite	VPD/27/SGR	1328	1369	1610
	Black	VPD/27/SBL	1328	1369	1610
	White	VPD/27/SWH	1454	1495	1736
	Eco	VPD/27/ECO	1454	1495	1736
29"	Silver	VPD/SS	1328	1369	1610
	Graphite	VPD/SGR	1328	1369	1610
	Black	VPD/SBL	1328	1369	1610
	White	VPD/SWH	1454	1495	1736
	Eco	VPD/ECO	1454	1495	1736
36"	Silver	VPD/36/SS	1625	1666	1906
	Graphite	VPD/36/SGR	1625	1666	1906
	Black	VPD/36/SBL	1625	1666	1906
	White	VPD/36/SWH	1751	1792	2032
	Eco	VPD/36/ECO	1751	1792	2032
41"	Silver	VPD/41/SS	1625	1666	1906
	Graphite	VPD/41/SGR	1625	1666	1906
	Black	VPD/41/SBL	1625	1666	1906
	White	VPD/41/SWH	1751	1792	2032
	Eco	VPD/41/ECO	1751	1792	2032

Dimensions – Width 51.5" Depth 39"

Links

[← Contents](#) [↗ Finishes](#)

Versatilis Butcher Block

Non-folding table

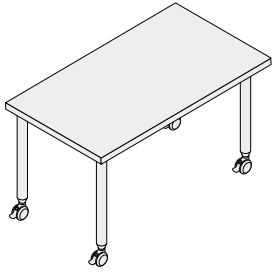

Height	Legs	Code	Price
14"	Silver	VR/14/75150/SS/BB	2973
	Graphite	VR/14/75150/SGR/BB	2973
	Black	VR/14/75150/SBL/BB	2973
	White	VR/14/75150/SWH/BB	3099
	Eco	VR/14/75150/ECO/BB	3099
25"	Silver	VR/25/75150/SS/BB	2973
	Graphite	VR/25/75150/SGR/BB	2973
	Black	VR/25/75150/SBL/BB	2973
	White	VR/25/75150/SWH/BB	3099
	Eco	VR/25/75150/ECO/BB	3099
27"	Silver	VR/27/75150/SS/BB	2973
	Graphite	VR/27/75150/SGR/BB	2973
	Black	VR/27/75150/SBL/BB	2973
	White	VR/27/75150/SWH/BB	3099
	Eco	VR/27/75150/ECO/BB	3099
29"	Silver	VR/75150/SS/BB	2973
	Graphite	VR/75150/SGR/BB	2973
	Black	VR/75150/SBL/BB	2973
	White	VR/75150/SWH/BB	3099
	Eco	VR/75150/ECO/BB	3099
36"	Silver	VR/36/75150/SS/BB	3270
	Graphite	VR/36/75150/SGR/BB	3270
	Black	VR/36/75150/SBL/BB	3270
	White	VR/36/75150/SWH/BB	3396
	Eco	VR/36/75150/ECO/BB	3396
41"	Silver	VR/41/75150/SS/BB	3270
	Graphite	VR/41/75150/SGR/BB	3270
	Black	VR/41/75150/SBL/BB	3270
	White	VR/41/75150/SWH/BB	3396
	Eco	VR/41/75150/ECO/BB	3396

Dimensions – Width 59" Depth 29.5"

Links

[← Contents](#) [↗ Finishes](#)

Versatilis Butcher Block

Non-folding table

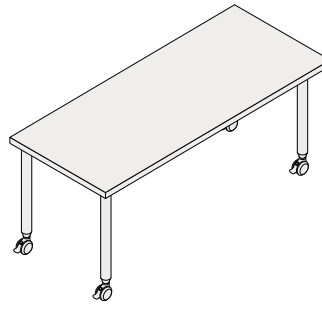

Height	Legs	Code	Price
14"	Silver	VR/14/75180/SS/BB	3206
	Graphite	VR/14/75180/SGR/BB	3206
	Black	VR/14/75180/SBL/BB	3206
	White	VR/14/75180/SWH/BB	3332
	Eco	VR/14/75180/ECO/BB	3332
25"	Silver	VR/25/75180/SS/BB	3206
	Graphite	VR/25/75180/SGR/BB	3206
	Black	VR/25/75180/SBL/BB	3206
	White	VR/25/75180/SWH/BB	3332
	Eco	VR/25/75180/ECO/BB	3332
27"	Silver	VR/27/75180/SS/BB	3206
	Graphite	VR/27/75180/SGR/BB	3206
	Black	VR/27/75180/SBL/BB	3206
	White	VR/27/75180/SWH/BB	3332
	Eco	VR/27/75180/ECO/BB	3332
29"	Silver	VR/75180/SS/BB	3206
	Graphite	VR/75180/SGR/BB	3206
	Black	VR/75180/SBL/BB	3206
	White	VR/75180/SWH/BB	3332
	Eco	VR/75180/ECO/BB	3332
36"	Silver	VR/36/75180/SS/BB	3503
	Graphite	VR/36/75180/SGR/BB	3503
	Black	VR/36/75180/SBL/BB	3503
	White	VR/36/75180/SWH/BB	3629
	Eco	VR/36/75180/ECO/BB	3629
41"	Silver	VR/41/75180/SS/BB	3503
	Graphite	VR/41/75180/SGR/BB	3503
	Black	VR/41/75180/SBL/BB	3503
	White	VR/41/75180/SWH/BB	3629
	Eco	VR/41/75180/ECO/BB	3629

Dimensions – Width 72" Depth 29.5"

Links

[← Contents](#) [↗ Finishes](#)

Versatilis Butcher Block

Non-folding table

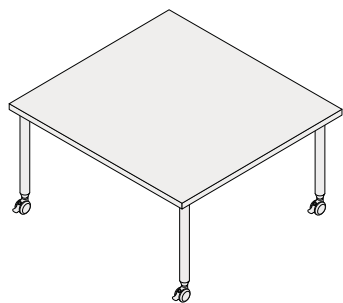

Height	Legs	Code	Price
14"	Silver	VR/14/120120/SS/BB	2973
	Graphite	VR/14/120120/SGR/BB	2973
	Black	VR/14/120120/SBL/BB	2973
	White	VR/14/120120/SWH/BB	3099
	Eco	VR/14/120120/ECO/BB	3099
25"	Silver	VR/25/120120/SS/BB	2973
	Graphite	VR/25/120120/SGR/BB	2973
	Black	VR/25/120120/SBL/BB	2973
	White	VR/25/120120/SWH/BB	3099
	Eco	VR/25/120120/ECO/BB	3099
27"	Silver	VR/27/120120/SS/BB	2973
	Graphite	VR/27/120120/SGR/BB	2973
	Black	VR/27/120120/SBL/BB	2973
	White	VR/27/120120/SWH/BB	3099
	Eco	VR/27/120120/ECO/BB	3099
29"	Silver	VR/120120/SS/BB	2973
	Graphite	VR/120120/SGR/BB	2973
	Black	VR/120120/SBL/BB	2973
	White	VR/120120/SWH/BB	3099
	Eco	VR/120120/ECO/BB	3099
36"	Silver	VR/36/120120/SS/BB	3270
	Graphite	VR/36/120120/SGR/BB	3270
	Black	VR/36/120120/SBL/BB	3270
	White	VR/36/120120/SWH/BB	3396
	Eco	VR/36/120120/ECO/BB	3396
41"	Silver	VR/41/120120/SS/BB	3270
	Graphite	VR/41/120120/SGR/BB	3270
	Black	VR/41/120120/SBL/BB	3270
	White	VR/41/120120/SWH/BB	3396
	Eco	VR/41/120120/ECO/BB	3396

Dimensions – Width 47.5" Depth 47.5"

Links

[← Contents](#) [↗ Finishes](#)

Versatilis Butcher Block

Non-folding table

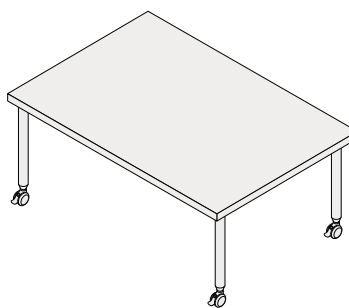

Height	Legs	Code	Price
14"	Silver	VR/14/180120/SS/BB	3681
	Graphite	VR/14/180120/SGR/BB	3681
	Black	VR/14/180120/SBL/BB	3681
	White	VR/14/180120/SWH/BB	3807
	Eco	VR/14/180120/ECO/BB	3807
25"	Silver	VR/25/180120/SS/BB	3681
	Graphite	VR/25/180120/SGR/BB	3681
	Black	VR/25/180120/SBL/BB	3681
	White	VR/25/180120/SWH/BB	3807
	Eco	VR/25/180120/ECO/BB	3807
27"	Silver	VR/27/180120/SS/BB	3681
	Graphite	VR/27/180120/SGR/BB	3681
	Black	VR/27/180120/SBL/BB	3681
	White	VR/27/180120/SWH/BB	3807
	Eco	VR/27/180120/ECO/BB	3807
29"	Silver	VR/180120/SS/BB	3681
	Graphite	VR/180120/SGR/BB	3681
	Black	VR/180120/SBL/BB	3681
	White	VR/180120/SWH/BB	3807
	Eco	VR/180120/ECO/BB	3807
36"	Silver	VR/36/180120/SS/BB	3978
	Graphite	VR/36/180120/SGR/BB	3978
	Black	VR/36/180120/SBL/BB	3978
	White	VR/36/180120/SWH/BB	4104
	Eco	VR/36/180120/ECO/BB	4104
41"	Silver	VR/41/180120/SS/BB	3978
	Graphite	VR/41/180120/SGR/BB	3978
	Black	VR/41/180120/SBL/BB	3978
	White	VR/41/180120/SWH/BB	4104
	Eco	VR/41/180120/ECO/BB	4104

Dimensions – Width 72" Depth 47.5"

Links

[← Contents](#) [↗ Finishes](#)

Versatilis Bot Builder

36" x 60"

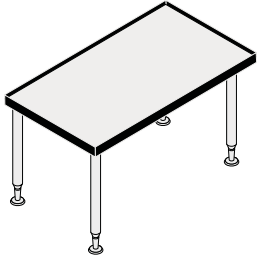

Height	Legs	Code	Price
14"	Silver	BBR/14/92153/SS-G	1603
25"	Silver	BBR/25/92153/SS-G	1603
27"	Silver	BBR/27/92153/SS-G	1603
29"	Silver	BBR/92153/SS-G	1603
36"	Silver	BBR/36/92153/SS-G	1726
41"	Silver	BBR/41/92153/SS-G	1726

Options	Code	Price
Muzo Caster	/CA	+104

Dimensions – Width 60" Depth 36"

Links

[← Contents](#) [↗ Finishes](#)

Versatilis Bot Builder

36" x 36"

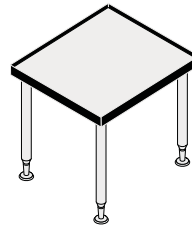

Height	Legs	Code	Price
14"	Silver	BBS/14/9292/SS-G	1451
25"	Silver	VBBS/25/9292/SS-G	1451
27"	Silver	BBS/27/9292/SS-G	1451
29"	Silver	BBS/9292/SS-G	1451
36"	Silver	BBS/36/9292/SS-G	1598
41"	Silver	BBS/41/9292/SS-G	1598

Options	Code	Price
Muzo Caster	/CA	+104

Dimensions – Width 36" Depth 36"

Links

[← Contents](#) [↗ Finishes](#)

Height adjustable leg kit

For Versatilis

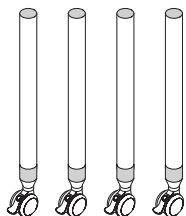

Legs	Size	Code	Price
Straight Silver	29-35"	HALKIT/SS	691
Straight Graphite	29-35"	HALKIT/SG	691
Straight Silver	25-31"	HALKIT/SS25-31	691

Glides

Feet for table legs

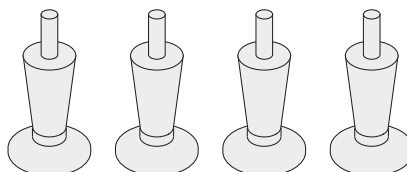

Code	Price
GLIDE	-104

Qpac

Wireless power unit

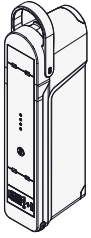

Finish	Code	Price
White	QP/B/WH/WH	1545
Black	QP/B/BL/BL	1545

Dimensions – Width 54.5" Depth 48"

Links

[← Contents](#)

Q-clip

Leg clip for Kite® and Versatilis



Finish	Code	Price
Black	QP/CL/BL	36

Dimensions – Width 28" Depth 32"

Links

[← Contents](#)

Q-dock

Charges 3 Qpacs

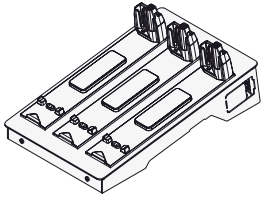

Product	Finish	Code	Price
Dock	White	QP/C/WH	1340
Starter 72" cord	-	QP/SC/72	44
Linking kit	-	QP/LK	42

Dimensions – Width 54.5" Depth 48"

Links

[← Contents](#)

ReCharge

Mobile cabinet charges up to 12 Qpacs

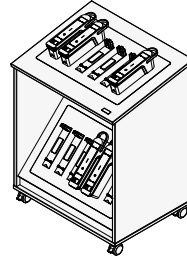

Code	Tier 1	Tier 2	Tier 3
RCG/12	8134	8134	POA

Dimensions – Width 28" Depth 32"

Links

[← Contents](#)

Juice Tree®

Wireless power station

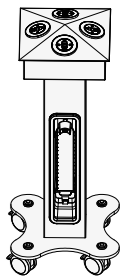

Finish	Qpac	Code	Price
Silver	White	JT/SI/WH	3890
White	White	JT/WH/WH	3890

Extra

Muzo 'powdura eco' powder coated body	+120
---------------------------------------	------

Dimensions – Height 31.5" Width 15.75"

Links

[← Contents](#) [↗ Finishes](#)

Juice Bot®

Flexible and fun wireless power

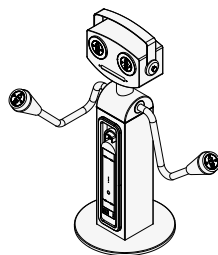

Product	Code	Price
Juice Bot Aux	JB/SI/50W	5980
Juice Bot	JB/SI	5120

Extra

Muzo 'powdura eco' powder coated body	+120
---------------------------------------	------

Dimensions

Aux - Height 33.5" Width 11.8"

Standard - Height 29.5" Width 11.8"

Dimensions

Aux - Height 33.5" Width 11.8"

Standard - Height 29.5" Width 11.8"

Links

[← Contents](#) [↗ Finishes](#)

Q-rise

Wireless height adjustable table



Height	Frame	Code	Tier 1
25.5 - 40.5"	Black	QP/R	4600

Dimensions – Width 60" Depth 30"

Links

[← Contents](#)

Powerball

Charging units

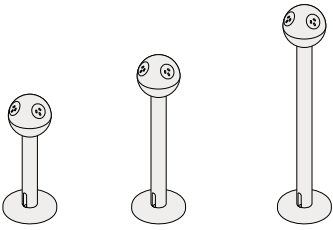

Color	Height	Code	Price
White	18"	PB/15	1 152
White	26.5"	PB/20	1 206
White	35"	PB/30	1 292

Desktop Powerball

Charging unit

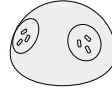

Color	Code	Price
Yellow	DTPB/Y	POA
Red	DTPB/R	POA
White	DTPB/WH	670
Blue	DTPB/B	POA

Dimensions – Width 7" Depth 7"

Links

[← Contents](#)

Dimensions – Height 3" Width 6"

Links

[← Contents](#)

Go Storage

Single Short Cart (Slimline)



Modules	Frame	Code	Price (trays not inc)
4	Standard	GO/SSC/S/4	1170
4	Eco color	GO/SSC/S/4/ECO	1346

Dimensions

W 15 ¾ x H 21 ½ x D 18

Go Storage

Single Tall Cart (Slimline)

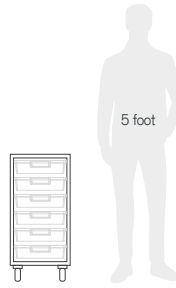

Modules	Frame	Code	Price (trays not inc)
6	Standard	GO/STC/S/6	1283
6	Eco color	GO/STC/S/6/ECO	1475

Dimensions

W 15 ¾ x H 29 ⅜ x D 18

Go Storage

Double Short Cart (Slimline)

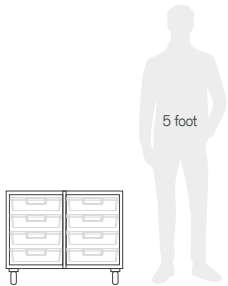

Modules	Frame	Code	Price (trays not inc)
8	Standard	GO/DSC/S/8	1462
8	Eco color	GO/DSC/S/8/ECO	1681

Dimensions

W 29 ½ x H 21 ½ x D 18

Go Storage

Double Tall Cart (Slimline)

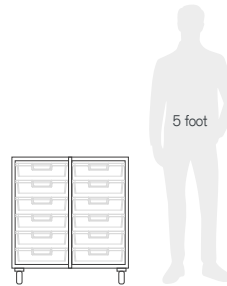

Modules	Frame	Code	Price (trays not inc)
12	Standard	GO/DTC/S/12	1629
12	Eco color	GO/DTC/S/12/ECO	1946

Dimensions

W 29 ½ x H 29 ⅜ x D 18

Tray reference	Size	Module space
	Single	1
	Double	2
	Triple	3
	Quad	4

Links

[← Contents](#) [↗ Finishes](#)

Go Storage

Triple Tall Cart (Slimline)

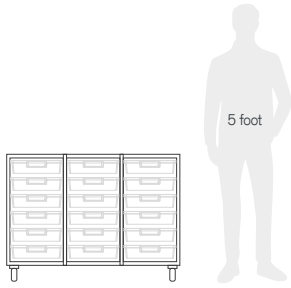

Modules	Code	Price (trays not inc)
18	GO/TTC/S/18	1845
18	GO/TTC/S/18/ECO	2122

Dimensions

W 43½ x H 29 ¾ x D 18

Go Storage

Single Mobile Tower (Slimline)

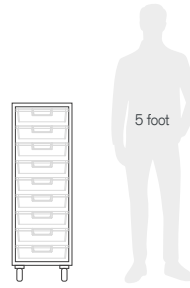

Modules	Code	Price (trays not inc)
9	GO/SMT/S/9	1395
9	GO/SMT/S/9/ECO	1604

Dimensions

W 15¾ x H 41¾ x D 18

Go Storage

Double Mobile Tower (Slimline)

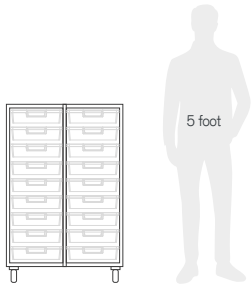

Modules	Code	Price (trays not inc)
18	GO/DMT/S/18	1778
18	GO/DMT/S/18/ECO	2045

Dimensions

W 29½ x H 41¾ x D 18

Go Storage

Triple Mobile Tower (Slimline)



Modules	Code	Price (trays not inc)
27	GO/TMT/S/27	2025
27	GO/TMT/S/27/ECO	2329

Dimensions

W 41½ x H 41¾ x D 18

Tray reference	Size	Module space
	Single	1
	Double	2
	Triple	3
	Quad	4

Links

[← Contents](#) [↗ Finishes](#)

Go Storage

Triple Mobile Tower (Slimline)

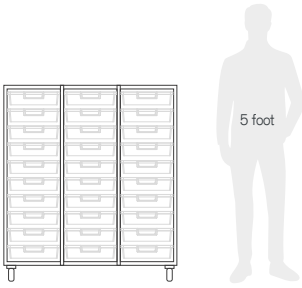

Modules	Code	Price (trays not inc)
30	GO/TMT/S/30	2250
30	GO/TMT/S/30/ECO	2586

Dimensions

W 43½ x H 45 x D 18

Go Storage

Single Short Cart (Wideline)

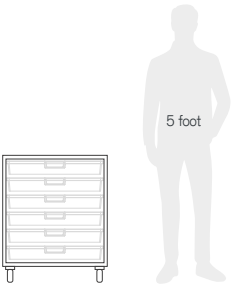

Modules	Code	Price (trays not inc)
6	GO/SSC/W/6	1373
6	GO/SSC/W/6/ECO	1579

Dimensions

W 21¾ x H 29¾ x D 18

Go Storage

Double Short Cart (Wideline)

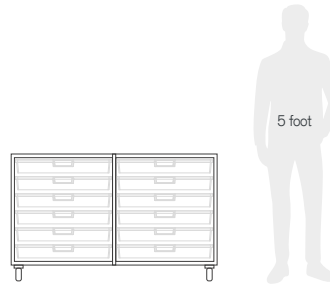

Modules	Code	Price (trays not inc)
12	GO/DSC/W/12	1778
12	GO/DSC/W/12/ECO	2045

Dimensions

W 41½ x H 29¾ x D 18

Tray reference	Size	Module space
	Single	1
	Double	2
	Triple	3
	Quad	4

Links

[← Contents](#) [↗ Finishes](#)

Go Storage

Double Mobile Tower (Wideline)

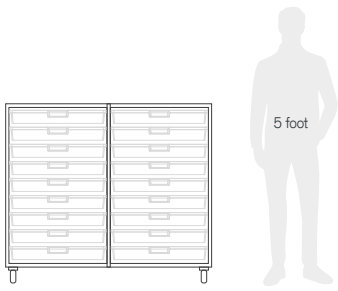

Modules	Code	Price (trays not inc)
18	GO/DMT/W/18	1868
18	GO/DMT/W/18/ECO	2148

Dimensions

W 41 $\frac{5}{8}$ x H 41 $\frac{3}{8}$ x D 18

Go Storage

Single Mobile Tower (Wideline)

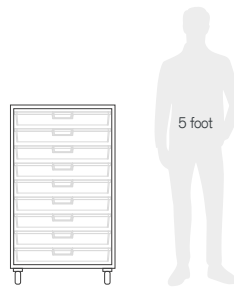

Modules	Code	Price (trays not inc)
9	GO/SMT/W/9	1485
9	GO/SMT/W/9/ECO	1708

Dimensions

W 21 $\frac{3}{4}$ x H 41 $\frac{3}{8}$ x D 18

Go Storage

Double Mobile Tower (Wide & Slimline)

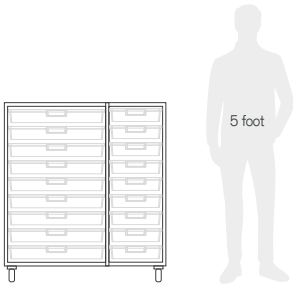

Modules	Code	Price (trays not inc)
18	GO/DMT/S/W/9/9	1800
18	GO/DMT/S/W/9/9/ECO	2070

Dimensions

W 35 $\frac{1}{2}$ x H 41 $\frac{3}{8}$ x D 18

Tray reference	Size	Module space
	Single	1
	Double	2
	Triple	3
	Quad	4

Links

[← Contents](#) [↗ Finishes](#)

Go Storage

Double Wall Unit (Slimline)

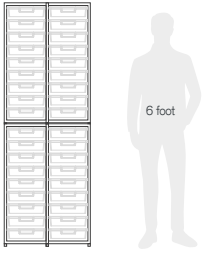

Modules	Code	Price (trays not inc)
36	GO/DWU/S/36	3668
36	GO/DWU/S/36/ECO	4218

Dimensions

W 28¾ x H 75½ x D 17

Go Storage

Triple Wall Unit (Slimline)

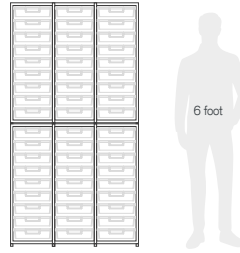

Modules	Code	Price (trays not inc)
54	GO/TWU/S/54	5760
54	GO/TWU/S/54/ECO	6612

Dimensions

W 42⅝ x H 75½ x D 17

Go Storage

Wall Unit - Shelf & Storage (Slimline)

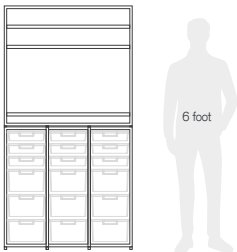

Modules	Code	Price (trays not inc)
27	GO/SSWU/S/27	5423
27	GO/SSWU/S/27/ECO	6236

Dimensions & Notes

W 42⅝ x H 75½ x D 17

Comes with 3 adjustable shelves that can be positioned and/or removed as required.

Links

[← Contents](#) [↗ Finishes](#)

Tray reference	Size	Module space
	Single	1
	Double	2
	Triple	3
	Quad	4

Go Storage

Single Wall Unit (Wide)

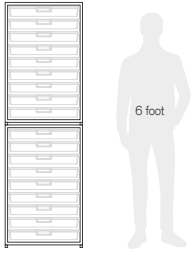

Modules	Code	Price (trays not inc)
18	GO/SWU/W/18	2948
18	GO/SWU/W/18/ECO	3390

Dimensions

W 20⁷/₈ x H 75¹/₂ x D 17

Go Storage

Double Wall Unit (Wide)

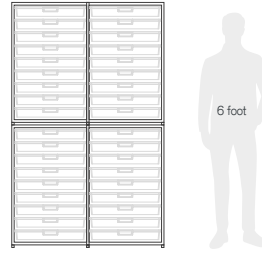

Modules	Code	Price (trays not inc)
36	GO/DWU/W/36	3736
36	GO/DWU/W/36/ECO	4296

Dimensions

W 40³/₄ x H 75¹/₂ x D 17

Links

[← Contents](#) [↗ Finishes](#)

Tray reference	Size	Module space
	Single	1
	Double	2
	Triple	3
	Quad	4

Go storage

Slim Line Trays

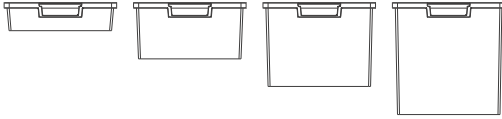

Height	Finish	Module space	Code	Price
Single 3"	Solid	1	GO/TR/S/1/SL	26
	Crystal	1	GO/TR/S/1/CL	34
Double 6"	Solid	2	GO/TR/S/2/SL	43
	Crystal	2	GO/TR/S/2/CL	57
Triple 9"	Solid	3	GO/TR/S/3/SL	53
	Crystal	3	GO/TR/S/3/CL	69
Quad 12"	Solid	4	GO/TR/S/4/SL	59
	Crystal	4	GO/TR/S/4/CL	81

Dimensions

Single	W 12¼ x H 3 x D 16¾
Double	W 12¼ x H 6 x D 16¾
Triple	W 12¼ x H 9 x D 16¾
Quad	W 12¼ x H 12 x D 16¾

Go storage

Wide Line Trays

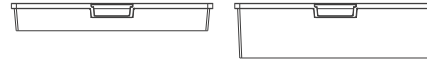

Height	Finish	Module space	Code	Price
Single 3"	Solid	1	GO/TRAY/W/1/SL	26
	Crystal	1	GO/TRAY/W/1/CL	34
Double 6"	Solid	2	GO/TRAY/W/2/SL	43
	Crystal	2	GO/TRAY/W/2/CL	57

Dimensions

Single	W 18½ x H 3 x D 16¾
Double	W 18½ x H 6 x D 16¾

How to calculate trays for carts

Note the module number of your chosen product

In this case the Single Short Cart (Slim) has 4 modules available.



As the Single 3" trays take up 1 module per tray, I can have 4 of these trays.

If I want Double 6" trays, I can have 2 of these trays as each one takes up 2 modules, and there are 4 modules available in this example.

If you need further assistance, please email info@muzo-works.com

Links

[← Contents](#) [↗ Finishes](#)

Go storage

Tray organizers

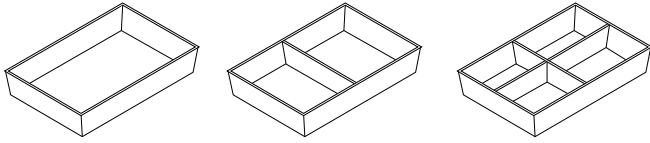

Divisions	Finish	Code	Price
1	Color	GO/OR/1	16
2	Color	GO/OR/2	16
4	Color	GO/OR/4	16

Dimensions

W 11¼ x H 2¼ x D 8

Go storage

Tray organizers (short and long)

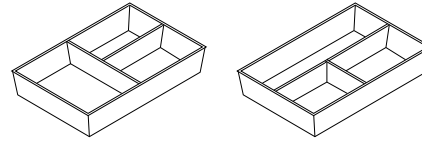

Divisions	Finish	Code	Price
3 (short)	Color	GO/OR/S/3	16
3 (long)	Color	GO/OR/L/3	16

Dimensions

W 11¼ x H 2¼ x D 8

Rolo

Storage seat

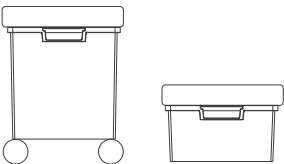

Height	Tray	Code	Solid tray	Crystal tray
12	Tall	GO/RL/T	239	262
12	Tall with casters	GO/RL/T/C	289	311
6	Medium	GO/RL/M	223	237

Dimensions

GO2000	W 13 x H 15 x D 17¼
GO2000-M	W 13 x H 17 x D 17¼
GO2001	W 13 x H 9 x D 17¼

Links

[← Contents](#) [↗ Finishes](#)

Go storage

Accessories

Products	Finish	Code	Price
Clear window & namecard	Clear	GO/TW-NC	1
Filing frame	Legal	GO/FF/LEGAL	83
	Letter	GO/FF/LETTER	83
Wide line divider set single depth	Pair	GO/WLDS/S	17
Wide line divider set double depth	Pair	GO/WLDS/S	24
Bench seat for slim line double carts	Topsy Turvy	GO/BEN/SL/TT	653

Stash mobile storage

Single width

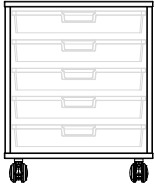

Modules	Height	Code	Top	Price
2	14.7	ST/CAB/S/2	Tier 1	1099
			Tier 2	1209
			Tier 3	1328
3	19	ST/CAB/S/3	Tier 1	1192
			Tier 2	1312
			Tier 3	1443
4	23.6	ST/CAB/S/4	Tier 1	1297
			Tier 2	1426
			Tier 3	1569
5	29.7	ST/CAB/S/5	Tier 1	1302
			Tier 2	1430
			Tier 3	1572
7	34.6	ST/CAB/S/7	Tier 1	1553
			Tier 2	1709
			Tier 3	1876

Doors can be fit on each compartment

POA

Overall Dimensions

Width 20.6" Depth 19.7"

Notes

Side and back finish is Wilsonart North Sea
Doors available, please contact us if this is something you require.

Links

[← Contents](#) [↗ Finishes](#)

Stash mobile storage

Double width

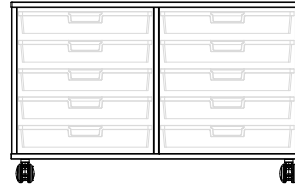

Modules	Height	Code	Top	Price
4	14.7	ST/CAB/D/4	Tier 1	1759
			Tier 2	1933
			Tier 3	2127
6	19	ST/CAB/D/6	Tier 1	1902
			Tier 2	2092
			Tier 3	2301
8	23.6	ST/CAB/D/8	Tier 1	2060
			Tier 2	2267
			Tier 3	2492
10	29.7	ST/CAB/D/10	Tier 1	2279
			Tier 2	2505
			Tier 3	2755
14	34.6	ST/CAB/D/14	Tier 1	2525
			Tier 2	2777
			Tier 3	3052

Doors can be fit on each compartment

POA

Overall Dimensions

Width 40.3" Depth 19.7"

Notes

Side and back finish is Wilsonart North Sea
Doors available, please contact us if this is something you require.

Links

[← Contents](#) [↗ Finishes](#)

Stash mobile storage

Triple width

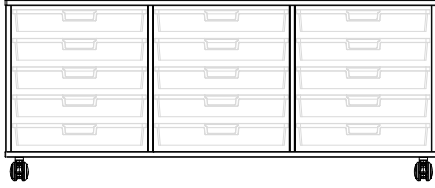

Modules	Height	Code	Top	Price
6	14.7	ST/CAB/T/6	Tier 1	2265
			Tier 2	2490
			Tier 3	2737
9	19	ST/CAB/T/9	Tier 1	2446
			Tier 2	2690
			Tier 3	2959
12	23.6	ST/CAB/T/12	Tier 1	2646
			Tier 2	2910
			Tier 3	3200
15	29.7	ST/CAB/T/15	Tier 1	2952
			Tier 2	3245
			Tier 3	3568
21	34.6	ST/CAB/T/21	Tier 1	3286
			Tier 2	3616
			Tier 3	3866

Doors can be fit on each compartment POA

Overall Dimensions

Width 60" Depth 19.7"

Notes

Side and back finish is Wilsonart North Sea
Doors available, please contact us if this is something you require.

Links

[← Contents](#) [↗ Finishes](#)

Stash mobile storage

Seat cushion

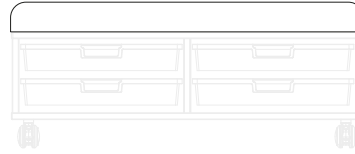

Width	Type	Code	Price
Single	Rigid	ST/SEAT/1/R	POA
Single	Velcro	ST/SEAT/1/V	POA
Double	Rigid	ST/SEAT/2/R	POA
Double	Velcro	ST/SEAT/2/V	POA
Triple	Rigid	ST/SEAT/3/R	POA
Triple	Velcro	ST/SEAT/3/V	POA

Notes

Rigid - Ply frame seat cushion upholstered in Impress wipe clean fabric.
Velcro - Upholstered in Impress wipe clean fabric with velcro tabs to attach to the Stash surface top.

Links

[← Contents](#) [↗ Finishes](#)

Stashbox

Single width

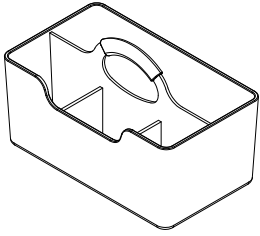

Height	Code	Color	Price
Container	ST/BOX/YE	Yellow	82
	ST/BOX/BU	Blue	82
	ST/BOX/WH	White	82
	ST/BOX/RE	Red	82
	ST/BOX/PI	Pink	82

Dimensions – Height 5" Width 12" Depth 7"

Links

[← Contents](#) [↗ Finishes](#)

Stash Cubby

Mobile storage unit

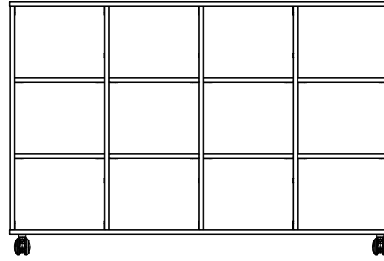

Compartments	Code	Top	Price
9	ST/CUB/9	Tier 1	2566
		Tier 2	2978
		Tier 3	3237
12	ST/CUB/12	Tier 1	2976
		Tier 2	3424
		Tier 3	3721

Doors

Doors can be fit on each compartment POA

Overall Dimensions

Cubby 9 compartments: Height 41" Width 46.5" Depth 19.5"

Cubby 12 compartments: Height 41" Width 61.5" Depth 19.5"

Notes

Side and back finish is Wilsonart North Sea

Doors available, please contact us if this is something you require.

Links

[← Contents](#) [↗ Finishes](#)

Innov-8

Multifunctional cart

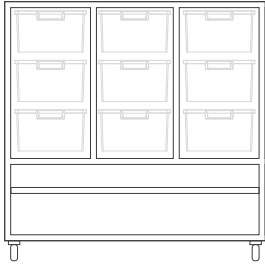

Unit	Code	Price
Innov-8	GO/INV8/S/18	6600

Notes

Not including trays

Dimensions – Height 44" Width 44.75" Depth 27.25"

Links

[← Contents](#) [↗ Finishes](#)

MBob

Floor seat

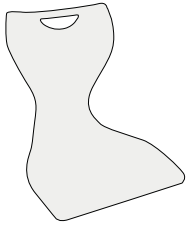

Seat height	Code	Price
Stackable floor seat	MBOB/	121

MBob

Reverse cantilever

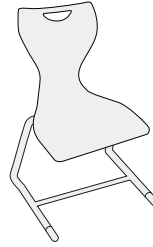

Seat Height	Width	Depth	Code	Price
18"	19"	24"	MBOB/5/18	210

Dimensions – Height 17.5" Width 16" Seat Depth 16"

Links

[← Contents](#) [↗ Finishes](#)

Dimensions – Various

Links

[← Contents](#) [↗ Finishes](#)

MBob

Classic chair

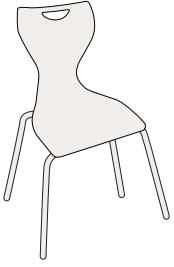

Seat height	Width	Depth	Code	Price
17"	18"	21.5"	MBOB/2/17	154
18"	18"	22"	MBOB/2/18	157

MBob

Computer chair



Type	Code	Price
With casters	MBOB/3/CA	220
With glides	MBOB/3/GL	210

Dimensions – Height 31.5" Width 17.75" Depth 21.5"

Links

[← Contents](#) [↗ Finishes](#)

Links

[← Contents](#) [↗ Finishes](#)

MBob

Stool

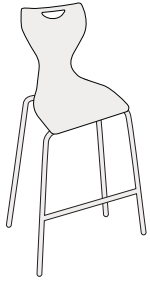

Seat height	Code	Price
24"	MBOB/4/24	233
26"	MBOB/4/26	239

K-stool

Stackable stool

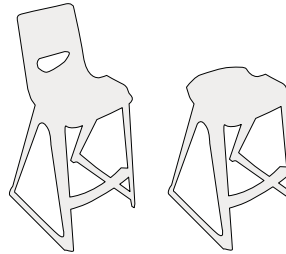

Type	Seat height	Code	Price
High back	27"	KSTOOL/H/27	204
High back	24"	KSTOOL/H/24	192
Low back	27"	KSTOOL/L/27	186
Low back	24"	KSTOOL/L/24	182

Accessories	Code	Price
Bag hook	KSTOOL/HOOK	12

Dimensions – Height 31.5" Width 17.75" Depth 21.5"

Links

[← Contents](#) [↗ Finishes](#)

Dimensions – Various

Links

[← Contents](#) [↗ Finishes](#)

K-seat

Stackable seat

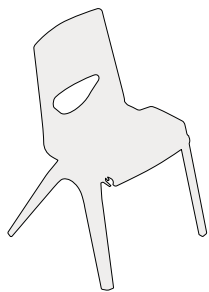

Height	Code	Price
12"	KSEAT/12	84
15"	KSEAT/15	93
18"	KSEAT/18	103

Accessories	Code	Price
Dolly cart	KSEAT/DOLLY	551

Dimensions – Various

Links

[← Contents](#) [↗ Finishes](#)

K-nect

Connecting table

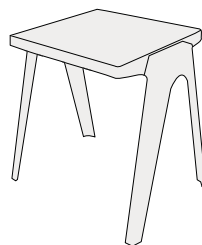

Height	Color	Code	Price
29.9"	Night Gray	KNECT/CT6	246

Accessories	Color	Code	Price
Linking device	Night Gray	KNECT/CTCON	56
Pen groove	Various	KNECT/CTPG	12
UV protecton	N/A	KNECT/CTUV	24
Table dolly	Ply base	KNECT/CTDOL	778

Dimensions – Various

Links

[← Contents](#) [↗ Finishes](#)

Lips

Rocking chair

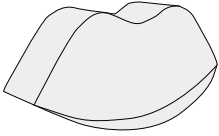

Fabric	Code	Price
Camira Blazer, Goldsmith CUZ39	LIPS/CF/GS	736
Camira Blazer, Penola CUZ2X	LIPS/CF/PE	736
Camira Blazer, Sheffield	LIPS/CF/SH	736
Camira Blazer, Stanford CUZ2R	LIPS/CF/ST	736
Camira Blazer, Woodcroft CUZ2Z	LIPS/CF/WC	736
Muzo Vinyl, Red	LIPS/MV/R	714

Dimensions – Height 17" Width 17" Depth 9.5"

Links

[← Contents](#)

R2

Seat with storage

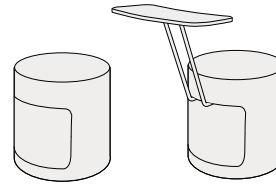

Fabric	Code	Price
Muzo Vinyl, Green	R2/MV/GR	589
Muzo Vinyl, Purple	R2/MV/PU	589
Muzo Vinyl, Red	R2/MV/RE	589
Maverik Morbern, Custom Color	R2/MM/CC	POA
W/Tablet, Muzo Vinyl, Green	R2-T/MV/GN	703
W/Tablet, Muzo Vinyl, Purple	R2-T/MV/PU	703
W/Tablet, Muzo Vinyl, Red	R2-T/MV/RD	703
W/Tablet, Maverik Morbern, Custom Color	R2-T/MM/CC	POA

Dimensions – Height 18.75" Width 24" Depth 24"

Links

[← Contents](#)

Puzzle

Jigsaw shape

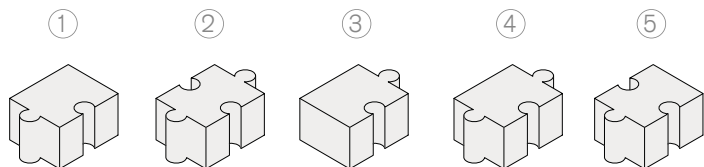

Type	Fabric	Code	Price
Shape 1	T1	PZL/JS1/T1	991
Shape 1	T2	PZL/JS1/T2	POA
Shape 2	T1	PZL/JS2/T1	991
Shape 2	T2	PZL/JS2/T2	POA
Shape 3	T1	PZL/JS3/T1	991
Shape 3	T2	PZL/JS3/T2	POA
Shape 4	T1	PZL/JS4/T1	991
Shape 4	T2	PZL/JS4/T2	POA
Shape 5	T1	PZL/JS5/T1	991
Shape 5	T2	PZL/JS5/T2	POA

T1 Finishes

- Camira — Blazer
- Gabriel — Europost 2
- Morbern — Maverick
- CF Stinson — Fuse 2.0
- Mayer — Hexagon
- Maharam — Facet

T2 Finishes

Customers own material

Dimensions – Height 17" Width 27" Depth 16"

Links

- Contents

Giant Donut

Soft furnishing

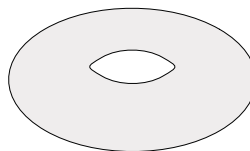

Fabric	Code	Price
Gabriel Step Fabric	DNT/GS	1953
Vinyl	DNT/V	POA

Finishes

- Gabriel Step Fabric

Dimensions – Height 15.75" Diameter 47.5"

Links

- Contents

Signs

Basic

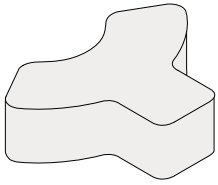

Color	Code	Price
One Color, T1 Fabric Choice	SNS/B1/T1	2331
One Color, T2 Fabric Choice	SNS/B1/T2	2760
Two Color, T1 Fabric Choice	SNS/B2/T1	2508
Two Color, T2 Fabric Choice	SNS/B2/T2	2992
Two Color, Tier Combo	SNS/B2/TC	2992

T1 Finishes

- Camira — Blazer
- Gabriel — Europost 2
- Morbern — Maverick
- CF Stinson — Fuse 2.0
- Mayer — Hexagon
- Maharam — Facet

T2 Finishes

Customers own material

Dimensions – Height 17" Width 58" Depth 42.5"

Links

- Contents

Signs

Corner

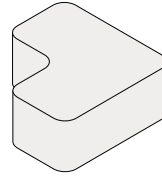

Color	Code	Price
One Color, T1 Fabric Choice	SNS/C1/T1	1880
One Color, T2 Fabric Choice	SNS/C1/T2	2170
Two Color, T1 Fabric Choice	SNS/C2/T1	2016
Two Color, T2 Fabric Choice	SNS/C2/T2	2310
Two Color, Tier Combo	SNS/C2/TC	2310

T1 Finishes

- Camira — Blazer
- Gabriel — Europost 2
- Morbern — Maverick
- CF Stinson — Fuse 2.0
- Mayer — Hexagon
- Maharam — Facet

T2 Finishes

Customers own material

Dimensions – Height 17" Width 39.5" Depth 39.5"

Links

- Contents

Signs

Square

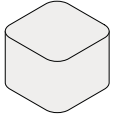

Color	Code	Price
One Color, T1 Fabric Choice	SNS/SQ1/T1	945
One Color, T2 Fabric Choice	SNS/SQ1/T2	1124
Two Color, T1 Fabric Choice	SNS/SQ2/T1	1010
Two Color, T2 Fabric Choice	SNS/SQ2/T2	1220
Two Color, Tier Combo	SNS/SQ2/TC	1220

T1 Finishes

- Camira — Blazer
- Gabriel — Europost 2
- Morbern — Maverick
- CF Stinson — Fuse 2.0
- Mayer — Hexagon
- Maharam — Facet

T2 Finishes

Customers own material

Dimensions – Height 17" Width 19.7" Depth 19.7"

Links

- Contents

Signs

2 seater

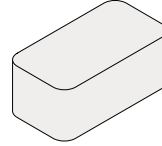

Color	Code	Price
One Color, T1 Fabric Choice	SNS/2S1/T1	1350
One Color, T2 Fabric Choice	SNS/2S1/T2	1600
Two Color, T1 Fabric Choice	SNS/2S2/T1	1470
Two Color, T2 Fabric Choice	SNS/2S2/T2	1784
Two Color, Tier Combo	SNS/2S2/TC	1784

T1 Finishes

- Camira — Blazer
- Gabriel — Europost 2
- Morbern — Maverick
- CF Stinson — Fuse 2.0
- Mayer — Hexagon
- Maharam — Facet

T2 Finishes

Customers own material

Dimensions – Height 17" Width 39.5" Depth 19.75"

Links

- Contents

Signs

3 seater

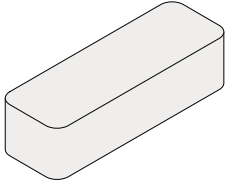

Color	Code	Price
One Color, T1 Fabric Choice	SNS/3S1/T1	1836
One Color, T2 Fabric Choice	SNS/3S1/T2	2211
Two Color, T1 Fabric Choice	SNS/3S2/T1	1981
Two Color, T2 Fabric Choice	SNS/3S2/T2	2357
Two Color, Tier Combo	SNS/3S2/TC	2357

T1 Finishes

- Camira — Blazer
- Gabriel — Europost 2
- Morbern — Maverick
- CF Stinson — Fuse 2.0
- Mayer — Hexagon
- Maharam — Facet

T2 Finishes

Customers own material

Dimensions – Height 17" Width 59" Depth 19.75"

Links

- Contents

Signs

Low circle

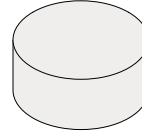

Color	Code	Price
One Color, T1 Fabric Choice	SNS/LC1/T1	1231
One Color, T2 Fabric Choice	SNS/LC1/T2	1492
Two Color, T1 Fabric Choice	SNS/LC2/T1	1328
Two Color, T2 Fabric Choice	SNS/LC2/T2	1628
Two Color, Tier Combo	SNS/LC2/TC	1628

T1 Finishes

- Camira — Blazer
- Gabriel — Europost 2
- Morbern — Maverick
- CF Stinson — Fuse 2.0
- Mayer — Hexagon
- Maharam — Facet

T2 Finishes

Customers own material

Dimensions – Height 17" Width 31.5" Depth 31.5"

Links

- Contents

Signs

High circle

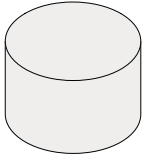

Color	Code	Price
One Color, T1 Fabric Choice	SNS/HC1/T1	1371
One Color, T2 Fabric Choice	SNS/HC1/T2	1657
Two Color, T1 Fabric Choice	SNS/HC2/T1	1474
Two Color, T2 Fabric Choice	SNS/HC2/T2	1905
Two Color, Tier Combo	SNS/HC2/TC	1905

T1 Finishes

- [Camira — Blazer](#)
- [Gabriel — Europost 2](#)
- [Morbern — Maverick](#)
- [CF Stinson — Fuse 2.0](#)
- [Mayer — Hexagon](#)
- [Maharam — Facet](#)

T2 Finishes

Customers own material

Dimensions – Height 25" Width 31.5" Depth 31.5"

Links

- [Contents](#)

Bebop

Active seat

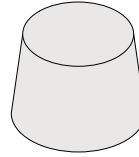

Color	Code	Price
One Color, T1 Fabric Choice	BBP/1/T1	1493
One Color, T2 Fabric Choice	BBP/1/T2	1613
Two Color, T1 Fabric Choice	BBP/2/T1	1576
Two Color, T2 Fabric Choice	BBP/2/T2	1702
Two Color, Tier Combo	BBP/2/TC	1702
Three Color, T1 Fabric Choice	BBP/3/T1	1734
Three Color, T2 Fabric Choice	BBP/3/T2	1872
Three Color, Tier Combo	BBP/3/TC	1872

T1 Finishes

- [Camira — Blazer](#)
- [Gabriel — Europost 2](#)
- [Morbern — Maverick](#)
- [CF Stinson — Fuse 2.0](#)
- [Mayer — Hexagon](#)
- [Maharam — Facet](#)

T2 Finishes

Customers own material

Dimensions – Height 21" Width 24" Depth 24"

Links

- [Contents](#)

Daywalker

Coffee table

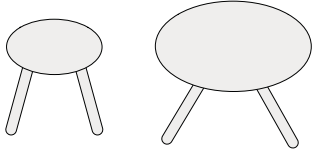

Type	Surface	Code	Price
550	Standard	DAY/55	1561
750	Standard	DAY/75	1779
	RAL Base		39

Dimensions

550 - Height 19.75" Width 21.75" Depth 21.75"

750 - Height 19.75" Width 29.5" Depth 29.5"

Links

[← Contents](#) [↗ Finishes](#)

Space Chicken / XL

Side table

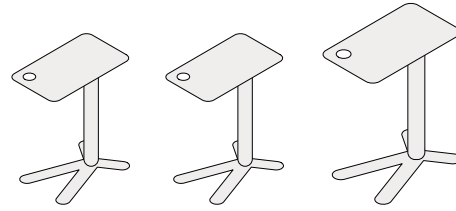

Height	Type	Code	Price
22.5"	Standard	SPCH/FH	1093
22.5-30"	Height adjustable	SPCH/HA	1561
	RAL Base		39
25.5-42"	Height adjustable	SPCH/XL	2140

Dimensions

Standard - Width 19" Depth 13"

XL - Width 23.5" Depth 16"

Links

[← Contents](#) [↗ Finishes](#)

Waltzer

High back mobile sofa

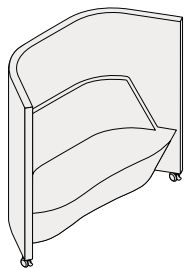

Fabric	Code	Price
T1 Fabric Choice	WZ/HB/T1	8483
T2 Fabric Choice	WZ/HB/T2	9850

T1 Finishes

- Camira — Blazer
- Gabriel — Europost 2
- Morbern — Maverick
- CF Stinson — Fuse 2.0
- Mayer — Hexagon
- Maharam — Facet

T2 Finishes

Customers own material

Dimensions – Height 56.5" Width 73.5" Depth 26"

Links

Contents

Waltzer

Low back mobile sofa

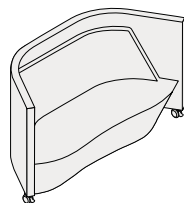

Fabric	Code	Price
T1 Fabric Choice	WZ/LB/T1	8359
T2 Fabric Choice	WZ/LB/T2	9656

T1 Finishes

- Camira — Blazer
- Gabriel — Europost 2
- Morbern — Maverick
- CF Stinson — Fuse 2.0
- Mayer — Hexagon
- Maharam — Facet

T2 Finishes

Customers own material

Dimensions – Height 35.5" Width 73.5" Depth 26"

Links

Contents

Waltzer work

High back workstation

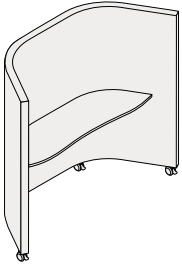

Fabric	Code	Price
T1 Fabric Choice	WZ/HW/T1	5637
T2 Fabric Choice	WZ/HW/T2	6736

T1 Finishes

- Camira — Blazer
- Gabriel — Europost 2
- Morbern — Maverick
- CF Stinson — Fuse 2.0
- Mayer — Hexagon
- Maharam — Facet

T2 Finishes

Customers own material

Dimensions – Height 56.5" Width 73.5" Depth 26"

Links

Contents

Waltzer screen

High back screen

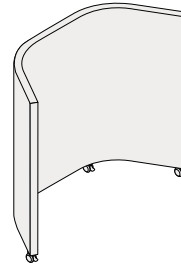

Fabric	Code	Price
T1 Fabric Choice	WZ/HSC/T1	5062
T2 Fabric Choice	WZ/HSC/T2	5736

T1 Finishes

- Camira — Blazer
- Gabriel — Europost 2
- Morbern — Maverick
- CF Stinson — Fuse 2.0
- Mayer — Hexagon
- Maharam — Facet

T2 Finishes

Customers own material

Dimensions – Height 56.5" Width 73.5" Depth 26"

Links

Contents

Woodland

Acoustic space divider

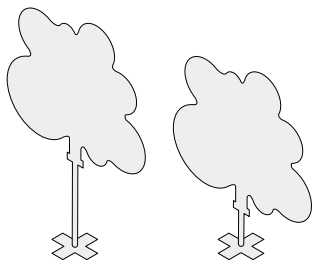

Type	Code	Price
High	WDL/H/	3023
Low	WDL/L/	2962

Finishes

- Camira — Blazer
- Gabriel — Europost 2

Dimensions
High - Height 73" Width 47" Depth 22"
Low - Height 53" Width 47" Depth 22"

Links

- Contents

Box Lounger

Acoustic lounge seat

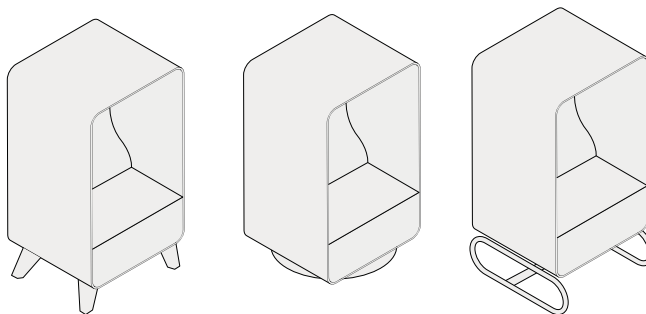

Base	Code	Price
Wooden legs	BL/LEG	8081
Swivel base	BL/SWIVEL	8403
Metal tube	BL/METAL	8081

Finishes

- Gabriel — Step

Dimensions – Height 60" Width 31.5" Depth 31.5"

Links

- Contents

M-Pod

Privacy lounge chair

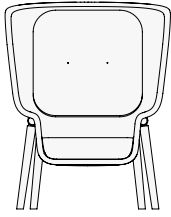

Type	Code	Price
Standard	MPOD/	9437

Custom options	Code	Price
Bespoke shell color	MPOD/CUST	9636

Finishes

[Kvadrat— Hallingdal 65](#)

Nook

Lounge chair

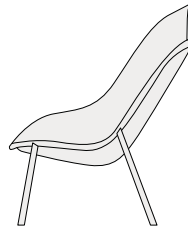

Type	Code	Price
Standard	NOOK/	4465

Custom options	Code	Price
Bespoke frame color	NOOK/F/CUST	4560
Bespoke shell color	NOOK/S/CUST	4584
Bespoke shell and frame color	NOOK/F/S/CUST	4679

Finishes

[Kvadrat— Hallingdal 65](#)

Dimensions – Height 51.25" Width 40" Depth 32.75"

Links

[← Contents](#) [↗ Finishes](#)

Dimensions – Height 104.5" Width 89" Depth 87.5"

Links

[← Contents](#) [↗ Finishes](#)

LJ1

Arm chair

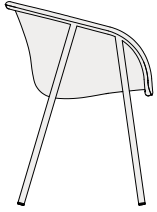

Type	Code	Price
Standard	LJ1/	996
Custom options	Code	Price
Bespoke frame color	LJ1/F/CUST	1091
Bespoke shell color	LJ1/S/CUST	1115
Bespoke shell and frame color	LJ1/F/S/CUST	1210

Dimensions – Height 31.25" Width 24.5" Depth 22.5"

Links

[← Contents](#) [↗ Finishes](#)

LJ2

Stacking chair



Type	Code	Price
Standard	LJ2/	915
Custom options	Code	Price
Bespoke frame color	LJ2/F/CUST	1010
Bespoke shell color	LJ2/S/CUST	1034
Bespoke shell and frame color	LJ2/F/S/CUST	1129

Dimensions – Height 31.1" Width 22.25" Depth 22.5"

Links

[← Contents](#) [↗ Finishes](#)

LJ3

Stool

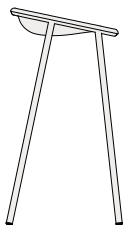

Type	Code	Price
Standard	LJ3/	786

Custom options	Code	Price
Bespoke frame color	LJ3/F/CUST	881
Bespoke shell color	LJ3/S/CUST	905
Bespoke shell and frame color	LJ3/F/S/CUST	1000

Dimensions – Height 34.25" Width 20.5" Depth 18.5"

Links

[← Contents](#) [↗ Finishes](#)

Switch task

Height adjustable task chair



Type	Code	Price
With height adjustable arms	SWTSK/A	1315
Seat options	Code	Price
Sliding seat	/SS	+119

Dimensions – Height 35-40" Width 26.8" Depth 26.8"

Links

[← Contents](#)

Switch

Flip and nest chair



Type	Code	Price
No arms	SWTC/NA	890
With height adjustable arms	SWTC/A	958

Dimensions – Height 35" Width 23" Depth 23"

Links

[← Contents](#)

Riveli

Solid aluminum magnetic shelf system

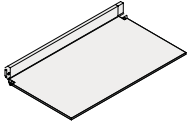

Options	Code	Price
Shelf	RIV1/	POA
Magnetic artwork panel	RIVART	POA
Magnetic whiteboard panel	RIVDRY	POA
Magnetic chalkboard panel	RIVCHALK	POA

Dimensions – Width 16" Depth 9"

Links

[← Contents](#)

PXL

Solid aluminum magnetic wall art

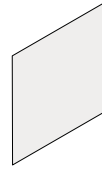

Options	Code	Price
Frame	PXL/	275
Magnetic artwork panel	PXLART	222
Magnetic whiteboard panel	PXLDRY	222
Magnetic chalkboard panel	PXLCHALK	222
Applicable artwork setup fee		250

Dimensions – Height 16" Width 16"

Links

[← Contents](#)

Flow

Mobile screens

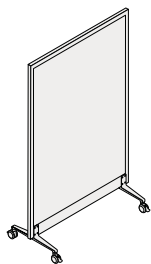

Screen	Width	Fabric	Code	Price
One screen	47.25"	Band 1	FS1/	2660
One screen	47.25"	COM	FS1/	POA
Two screen	97"	Band 1	FS2/	4898
Two screen	97"	COM	FS2/	POA
Three screen	147"	Band 1	FS3/	7368
Three screen	147"	COM	FS3/	POA

Dimensions – Height 71.5"

Links

[← Contents](#)

A-frame

Indoor/outdoor bench

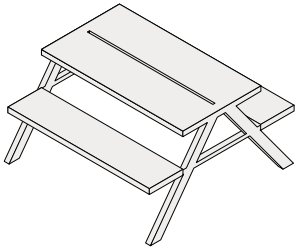

Product	Seats	Code	Price
Unit	6 seater	AFM/6	10566
Unit	8 seater	AFM/8	11622

A-frame Demountable

Indoor/outdoor bench

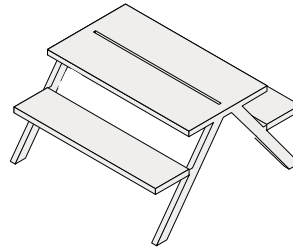

Product	Seats	Code	Price
Unit	6 seater	AFM-D/6	8506
Unit	8 seater	AFM-D/S8/230	9826

Dimensions – Width 54.5" Depth 48"

Links

[← Contents](#) [↗ Finishes](#)

Dimensions – Width 28" Depth 32"

Links

[← Contents](#) [↗ Finishes](#)

Alfresco Bench

Indoor/outdoor table and bench

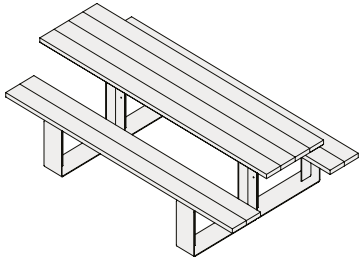

Product	Seats	Width x Depth x Height	Code	Price
Metal surface	8	79" x 57" x 29.5"	ALF/S8/AL	13400
Metal surface	10	94.5" x 57" x 29.5"	ALF/S10/AL	15684
Wood surface	8	79" x 57" x 29.5"	ALF/S8/IR	17494
Wood surface	10	94.5" x 57" x 29.5"	ALF/S10/IR	20625
Indoor tops			Code	Price
Birch ply			/BP	as listed
Custom laminate			/CL	POA
Butcher block			/BB	POA
Outdoor tops			Code	Price
Solid iroko			/IR	as listed
Aluminum powder coat			/APC	as listed
Thermal treated wood			/TTW	POA

Links

[← Contents](#) [↗ Finishes](#)

Alfresco Mini

Indoor/outdoor bench

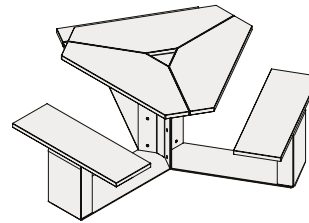

Top	Seats	Code	Price
Birch ply	3 seater	ALFM/3/BP	12140
Birch ply	6 seater	ALFM/6/BP	14011
Solid iroko	3 seater	ALFM/3/IR	13465
Solid iroko	6 seater	ALFM/6/IR	15224
Aluminum	3 seater	ALFM/3/AL	13465
Aluminum	6 seater	ALFM/6/AL	15224
Alfresco Umbrella		Code	Price
Standard		ALFM/UMB/	1493
Printed		ALFM/UMB/PR	1645
Indoor tops		Code	Price
Birch ply		/BP	as listed
Custom laminate		/CL	POA
Butcher block		/BB	POA
Outdoor tops		Code	Price
Solid iroko		/IR	as listed
Aluminum powder coat		/APC	as listed
Thermal treated wood		/TTW	POA

Links

[← Contents](#) [↗ Finishes](#)

Angle

Indoor/outdoor table and bench

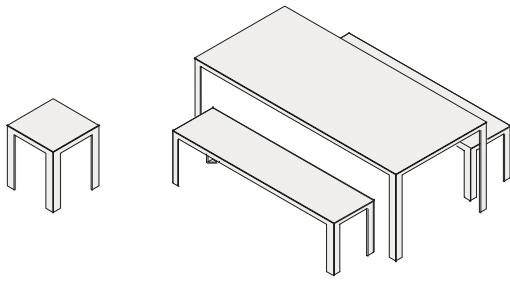

Product	Seats	Width x Depth	Code	Price
Table	4 seater	36" X 36"	AGL/S4	4573
Table	6 seater	71" X 35.5"	AGL/S6	7325
Table	8 seater	90.5" X 35.5"	AGL/S8	8307
Stool	1 seater	16" X 16"	AGL/STOOL	1364
Bench	3 seater	59" X 16"	AGL/BE3	3804
Bench	4 seater	74" X 16"	AGL/BE4	3873

Heights

Angle table available at heights of 20", 22", 25" and 29".

Bench and stool available at heights of 12", 14", 16" and 18".

Pricing remains the same for all heights.

Links

[← Contents](#) [↗ Finishes](#)

Block

Indoor/outdoor table and bench

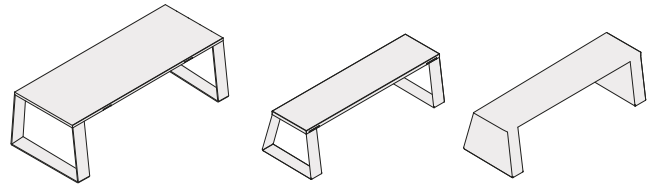

Product	Seats	Width x Depth x Height	Code	Price
Table	2 seater	35.5" x 28" x 29.5"	BLK/T/S2/	6502
Table	4 seater	59" x 28" x 29.5"	BLK/T/S4/	7507
Table	6 seater	79" x 28" x 29.5"	BLK/T/S6/	8275
Table	8 seater	90.5" x 28" x 29.5"	BLK/T/S8/	8688
Bench	1 seater	20" x 12" x 18"	BLK/B/S1/	2886
Bench	2 seater	43.5" x 12" x 18"	BLK/B/S2/	3245
Bench	3 seater	63" x 12" x 18"	BLK/B/S3/	3465
Bench	4 seater	75" x 12" x 18"	BLK/B/S4/	3686
End Bench	1 seater	20" x 12" x 18"	BLK/EB/S1/	2046
End Bench	2 seater	43.5" x 12" x 18"	BLK/EB/S2/	2820
End Bench	3 seater	63" x 12" x 18"	BLK/EB/S3/	2995
End Bench	4 seater	75" x 12" x 18"	BLK/EB/S4/	3198

Indoor tops

	Code	Price
Birch ply	/BP	as listed
Custom laminate	/CL	POA
Butcher block	/BB	POA

Outdoor tops

	Code	Price
Solid iroko	/IR	as listed
Aluminum powder coat	/APC	as listed
Thermal treated wood	/TTW	POA

Links

[← Contents](#) [↗ Finishes](#)

Box planter

Indoor/outdoor mobile planter

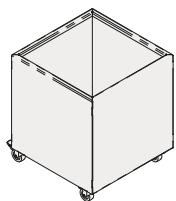

Size	Code	Price
15.75" x 15.75" x 18.5"	PLT/B/4040/C	2159
23.5" x 23.5" x 25"	PLT/B/6060/C	3397
47" x 15.75" x 18.5"	PLT/B/12040/C	4387
59" x 27.5" x 27.5"	PLT/B/15070/P	7244

Drum planter

Indoor/outdoor mobile planter



Size	Code	Price
15.75"Dia x 23.6" H	PLT/D/T/	1743
15.75"Dia x 19.6" H	PLT/D/	1634
19.6" Dia x 11.8" H	PLT/D/L/	1502

Links

[← Contents](#) [↗ Finishes](#)

Links

[← Contents](#) [↗ Finishes](#)

Edge

Indoor/outdoor table and bench

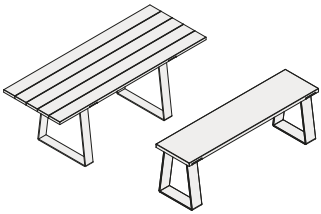

Product	Seats	Height x Width x Depth	Code	Price
Table	6 seater	29.5" x 63" x 27.5"	EDG/T/S6	9424
Table	8 seater	29.5" x 79" x 27.5"	EDG/T/S8	10320
Bench	3 seater	18" x 63" x 14"	EDG/B/S3	3336
Bench	4 seater	18" x 79" x 14"	EDG/B/S4	3644

Indoor tops	Code	Price
Birch ply	/BP	as listed
Custom laminate	/CL	POA
Butcher block	/BB	POA

Outdoor tops	Code	Price
Solid iroko	/IR	as listed
Aluminum powder coat	/APC	as listed
Thermal treated wood	/TTW	POA

Linear

Indoor/outdoor bench

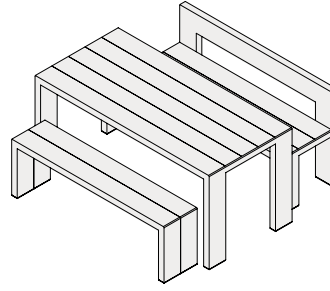

Product	Seats	Width x Depth x Height	Code	Price
Table	6 seater	63" x 30" x 29.5"	LNR/T/S6	8510
Bench	3 seater	51" x 12" x 18"	LNR/B/S3	3609
Back-bench	3 seater	51" x 12" x 18"	LNR/B-B/S3	6117

Links

[← Contents](#) [↗ Finishes](#)

Links

[← Contents](#) [↗ Finishes](#)

Ping-Pong

Indoor/outdoor table

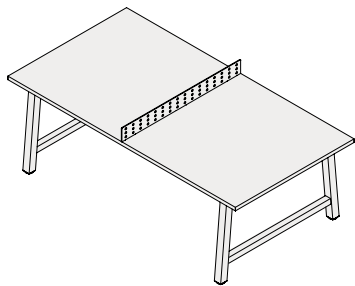

Product	Width x Depth x Height	Code	Price
Outdoors	90.5" x 47" x 30"	PNG/	12877

Tall Trestle

Indoor/outdoor table and bench

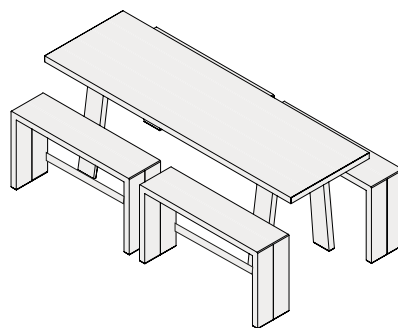

Product	Seats	Width x Depth x Height	Code	Price
Table	6	63" x 36" x 41.5"	TTRL/T/S6	12260
Bench	3	63" x 12" x 29.5"	TTRL/B/S3	7371
Table	8-12	94.5" x 36" x 41.5"	TTRL/T/S8	16203
Bench	2	43.5" x 12" x 29.5"	TTRL/B/S2	6975

Links

[← Contents](#) [↗ Finishes](#)

Links

[← Contents](#) [↗ Finishes](#)

Tri & Tall Tri Stool

Indoor/outdoor stool

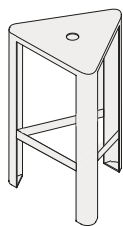

Product	Width x Depth x Height	Code	Price
Tall Tri Stool	20" x 18" x 29.5"	STL/T/30	2158
Tri Stool	18" x 16" x 18"	STL/T/18	1618

Trestle

Indoor/outdoor table and bench

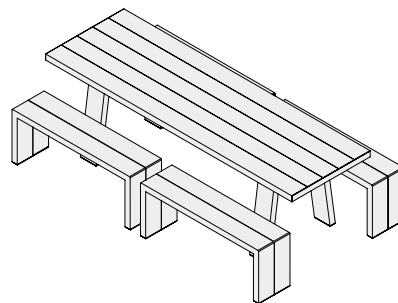

Product	Seats	Width x Depth x Height	Code	Price
Table	8-12 seater	94.5" x 30" x 29.5"	TRL/T/S8	10731
Table	6 seater	63" x 30" x 29.5"	TRL/T/S6	9098
Bench	3 seater	63" x 12" x 18"	TRL/B/S3	3266
Bench	2 seater	43.5" x 12" x 18"	TRL/B/S2	2940

Links

[← Contents](#) [↗ Finishes](#)

Links

[← Contents](#) [↗ Finishes](#)

Town

Indoor/Outdoor seat

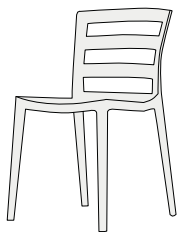

Color	Code	Price
White	TWN/WH	485
Anthracite	TWN/AN	485
Yellow	TWN/YE	485
Bordeaux	TWN/BO	485
Dove Gray	TWN/DG	485
English Green	TWN/EG	485

Dimensions – Height 17.5" Width 16" Seat Depth 16"

Links

[← Contents](#) [↗ Finishes](#)

Java

Indoor/outdoor table

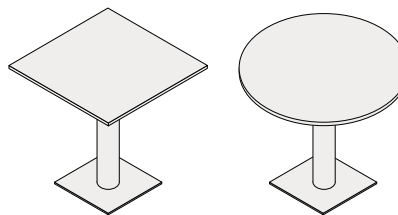

Square	Top	Code	Price
24" W x 24" D	White outdoor laminate	JTS/6060	1228
29.5" W x 29.5" D	White outdoor laminate	JTS/7575	1358
Circle			
29.5" Diameter	White outdoor laminate	JFC/75	1358

Dimensions – Height 29"

Links

[← Contents](#) [↗ Finishes](#)

Love seat

Wire seat

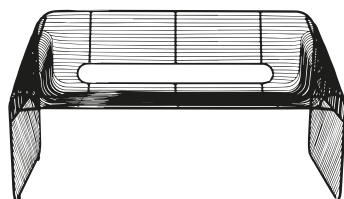

Product	Width x Depth x Height	Code	Price
Seat	49" x 23.25" x 26.5"	LST	2633
Seat pad	39.5" x 17" x 1"	LST/P	248

Hot seat

Wire seat

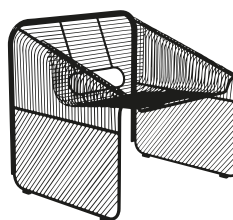

Product	Width x Depth x Height	Code	Price
Seat	28" x 23.5" x 26.5"	HST	2260
Seat pad	18" x 17" x 1"	HST/P	221

Links

[← Contents](#) [↗ Finishes](#)

Links

[← Contents](#) [↗ Finishes](#)

Switcher

Wire side table

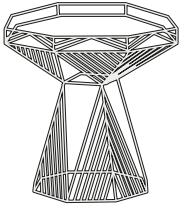

Product	Diameter x Height	Code	Price
Table	12" x 17"	SWR/B	944
Terrazo top		SWR/T	477
Black Pad		SWR/P/BL	248
White Pad		SWR/P/WH	248

Links

[← Contents](#) [↗ Finishes](#)

Flomo

Mobile Magnetic Dry Erase Board

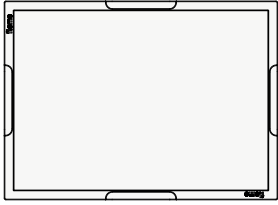

Product	Code	Price
Flomo Mobile Magnetic Dry Erase Board	FLOMO/B	1609
Flomo Caddy on Casters	FLOMO/C	1479
Flomo Folding Easel with Pen Tray	FLOMO/E	1352
Flomo Gecko	FLOMO/G	135
Flomo Carry or Shoulder Strap	FLOMO/S	103
Flomo Velcro Belt	FLOMO/V	103
Flomo Rail	FLOMO/R	580

Notes

Dimensions

W 37 x H 50.5 x D 1.5

Links

[← Contents](#) [↗ Finishes](#)

Xbrick

Multifunctional module

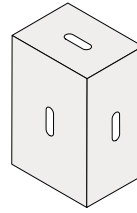

Type	Color	Code	Price
Xbrick	Black	XBRICK/BL	225
Xbrick	Light Gray	XBRICK/LG	255
Xbrick	Orange	XBRICK/OR	281
Xbrick	Yellow	XBRICK/YW	281
Xbrick	Green	XBRICK/GN	281
Xbrick	Ocean	XBRICK/OC	281
Xbrick	Blue	XBRICK/BU	281
Xbrick	Magenta	XBRICK/MG	281
Xbrick	Red	XBRICK/RE	281
X-connector	Wood	XCONN	43

Notes

Dimensions

W 13.25 x H 19.75 x D 9.85

Links

[← Contents](#) [↗ Finishes](#)

Xbench

Wooden bench top for Xbricks

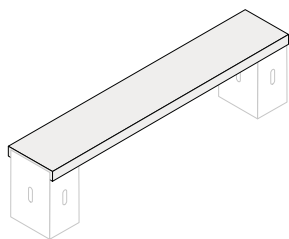

Product	Code	Price
Xbench top (Xbricks not included)	XBENCH/37180	972

Xtable

Table top for Xbricks

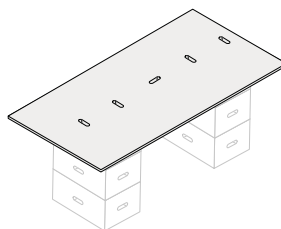

Type	Code	Price
Xtable top (Xbricks not included)	XTABLE/90180	1380
X-belt	XBELT/BL	103

Notes

Dimensions

W 80 x H 2.5 x D 14.5

Links

[← Contents](#)

Notes

Dimensions

W 71 x H 0.75 x D 35.5

Links

[← Contents](#)

Shadowspec Unity UNO

8' x 8' shade area

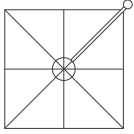

Product	Code	Price
Rotating umbrella and base	UTY/1/8x8	9715
Caster Kit For Free Standing Base	/CA	+364
Surface Mounted Bolt Down Base	/SM	+0
LED Lights with rechargeable batteries	/L1	+476

Notes

Price includes free standing base
Pavers to be supplied by others
16 pavers required per base
Paver dimensions are to be 15" x 15" x 1.5"

Installation is required - full detailed instructions for installation are provided upon delivery.

Links

[← Contents](#) [↗ Finishes](#)

Shadowspec Unity UNO

10' x 10' shade area

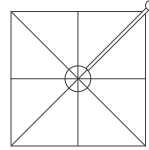

Product	Code	Price
Rotating umbrella and base	UTY/1/10x10	10,358
Caster Kit For Free Standing Base	/CA	+364
Surface Mounted Bolt Down Base	/SM	+0
LED Lights with rechargeable batteries	/L1	+476

Notes

Price includes free standing base
Pavers to be supplied by others
16 pavers required per base
Paver dimensions are to be 15" x 15" x 1.5"

Installation is required - full detailed instructions for installation are provided upon delivery.

Links

[← Contents](#) [↗ Finishes](#)

Shadowspec Unity DUO

8' x 16' shade area

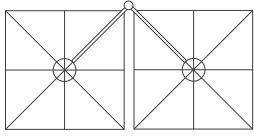

Product	Code	Price
Rotating umbrella and base	UTY/1/8x16	15315
Caster Kit For Free Standing Base	/CA	+364
Surface Mounted Bolt Down Base	/SM	+0
LED Lights with rechargeable batteries	/L2	+950

Notes

Price includes free standing base
Pavers to be supplied by others
16 pavers required per base
Paver dimensions are to be 15" x 15" x 1.5"

Installation is required - full detailed instructions for installation are provided upon delivery.

Links

[← Contents](#) [↗ Finishes](#)

Shadowspec Unity DUO

10' x 20' shade area

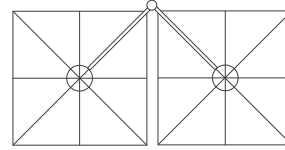

Product	Code	Price
Rotating umbrella and base	UTY/1/10x20	16764
Caster Kit For Free Standing Base	/CA	+364
Surface Mounted Bolt Down Base	/SM	+0
LED Lights with rechargeable batteries	/L2	+950

Notes

Price includes free standing base
Pavers to be supplied by others
16 pavers required per base
Paver dimensions are to be 15" x 15" x 1.5"

Installation is required - full detailed instructions for installation are provided upon delivery.

Links

[← Contents](#) [↗ Finishes](#)

Shadowspec Unity TRIO

8' x 16' + 8' x 8' shade area

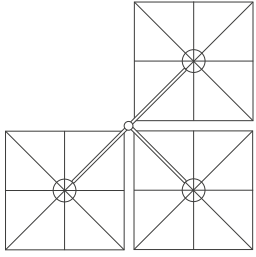

Product	Code	Price
Rotating umbrella and base	UTY/3/8x8+8x16	21,241
Caster Kit For Free Standing Base	/CA	+364
Surface Mounted Bolt Down Base	/SM	+0
LED Lights with rechargeable batteries	/L3	+1398

Notes

Price includes free standing base
Pavers to be supplied by others
16 pavers required per base
Paver dimensions are to be 15" x 15" x 1.5"

Installation is required - full detailed instructions for installation are provided upon delivery.

Links

[← Contents](#) [↗ Finishes](#)

Shadowspec Unity TRIO

10' x 20' + 10' x 10' shade area

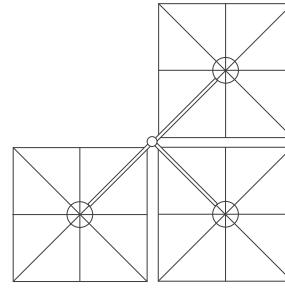

Product	Code	Price
Rotating umbrella and base	UTY/3/10x10+10x20	23,171
Caster Kit For Free Standing Base	/CA	+364
Surface Mounted Bolt Down Base	/SM	+0
LED Lights with rechargeable batteries	/L3	+1398

Notes

Price includes free standing base
Pavers to be supplied by others
16 pavers required per base
Paver dimensions are to be 15" x 15" x 1.5"

Installation is required - full detailed instructions for installation are provided upon delivery.

Links

[← Contents](#) [↗ Finishes](#)

Shadowspec Unity QUATTRO

16' x 16' shade area

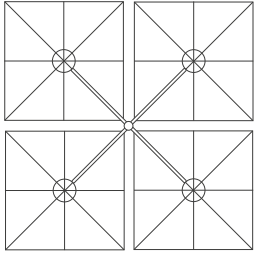

Product	Code	Price
Rotating umbrella and base	UTY/4/16x16	27,004
Caster Kit For Free Standing Base	/CA	+364
Surface Mounted Bolt Down Base	/SM	+0
LED Lights with rechargeable batteries	/L4	+1764

Notes

Price includes free standing base
Pavers to be supplied by others
16 pavers required per base
Paver dimensions are to be 15" x 15" x 1.5"

Installation is required - full detailed instructions for installation are provided upon delivery.

Links

[← Contents](#) [↗ Finishes](#)

Shadowspec Unity QUATTRO

20' x 20' shade area

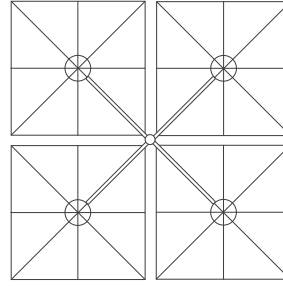

Product	Code	Price
Rotating umbrella and base	UTY/4/20x20	29,577
Caster Kit For Free Standing Base	/CA	+364
Surface Mounted Bolt Down Base	/SM	+0
LED Lights with rechargeable batteries	/L3	+1764

Notes

Price includes free standing base
Pavers to be supplied by others
16 pavers required per base
Paver dimensions are to be 15" x 15" x 1.5"

Installation is required - full detailed instructions for installation are provided upon delivery.

Links

[← Contents](#) [↗ Finishes](#)

Top finishes for Kite®



Tier 1 laminate

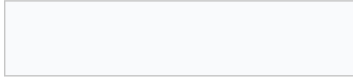

Designer White (DW)

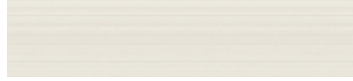

Highrise (HR)

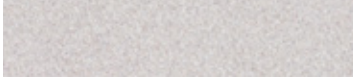

Titanium Ev (TE)



Pewter Brush (PB)



Kensington Maple (KM)



Sterling Ash (SA)



North Sea (NS)



Black (BL)

Tier 2 laminate



Shadow Zephyr (SZ)



Dove Grey (DG)



Pressed Linen (PL)



Graphite Nebula (GN)



Grey Elm (GE)



Beigewood (BW)

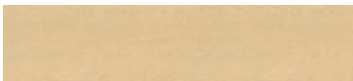

Fusion Maple (FM)



Asian Night (AN)

Tier 3 laminate

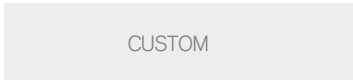

Custom Laminates (CL)



Whiteboard



Wilsonart Premium



Formica



Pionite



Nevamar

Leg finishes for Kite®



Standard



Silver (SI)



Graphite (SGR)



Black (SBL)



White (SWH)



Chrome (SCH)

Eco Colors



Optimism yellow (OP)



Collaboration orange (CO)



Passion red (PS)



Imagination green (IM)



Creativity teal (CR)



Zen (ZN)

Top finishes for Mini Mobile



Tier 1 laminate

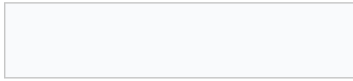

Designer White (DW)

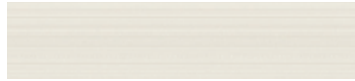

Highrise (HR)



Titanium Ev (TE)



Pewter Brush (PB)



Kensington Maple (KM)



Sterling Ash (SA)



North Sea (NS)



Black (BL)

Tier 2 laminate

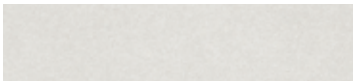

Shadow Zephyr (SZ)



Dove Grey (DG)

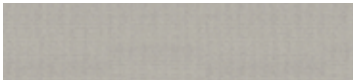

Pressed Linen (PL)



Graphite Nebula (GN)



Grey Elm (GE)



Beigewood (BW)

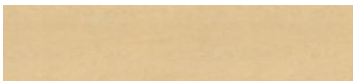

Fusion Maple (FM)



Asian Night (AN)

Tier 3 laminate

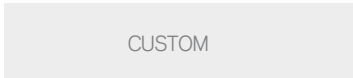

CUSTOM

Custom Laminate (CL)



Whiteboard

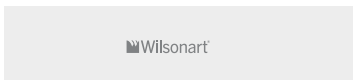

Wilsonart

Wilsonart Premium



FORMICA

Formica



PIONITE
DECORATIVE SURFACES

Pionite



NEVAMAR
DECORATIVE SURFACES

Nevamar

Leg finishes for Mini Mobile



Standard



Silver (SI)



Graphite (SGR)



Black (SBL)



White (SWH)



Chrome (SCH)



Tapered Silver (TSL)

Eco Colors



Optimism yellow (OP)



Collaboration orange (CO)



Passion red (PS)



Imagination green (IM)



Creativity teal (CR)



Zen (ZN)

Top finishes for Versatilis



Tier 1 laminate



Designer White (DW)



Highrise (HR)



Titanium Ev (TE)



Pewter Brush (PB)



Kensington Maple (KM)



Sterling Ash (SA)



North Sea (NS)



Black (BL)

Tier 2 laminate

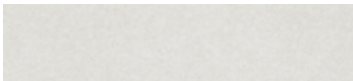

Shadow Zephyr (SZ)



Dove Grey (DG)

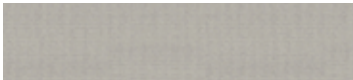

Pressed Linen (PL)



Graphite Nebula (GN)



Grey Elm (GE)



Beigewood (BW)

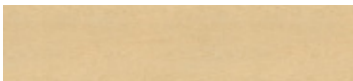

Fusion Maple (FM)



Asian Night (AN)

Tier 3 laminate

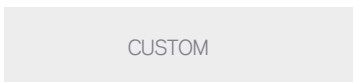

CUSTOM

Custom Laminate (CL)



Whiteboard



Wilsonart

Wilsonart Premium



FORMICA

Formica



PIONITE
DECORATIVE SURFACES

Pionite



NEVAMAR
DECORATIVE SURFACES

Nevamar

Leg finishes for Versatilis



Standard



Silver (SI)



Graphite (SGR)



Black (SBL)



White (SWH)

Eco Colors



Optimism yellow (OP)



Collaboration orange (CO)



Passion red (PS)



Imagination green (IM)



Creativity teal (CR)



Zen (ZN)

Finishes for Juice Tree®



Standard



Silver (SI)



White (WH)

Eco Colors



Optimism yellow (OP)



Collaboration orange (CO)



Passion red (PS)



Imagination green (IM)



Creativity teal (CR)



Zen (ZN)

Finishes for Juice Bot®



Standard



Silver (SI)

Eco Colors



Optimism yellow (OP)



Collaboration orange (CO)



Passion red (PS)



Imagination green (IM)



Creativity teal (CR)



Zen (ZN)



Standard



Silver (SI)



White (WH)

Eco Colors



Optimism yellow (OP)



Collaboration orange (CO)



Passion red (PS)



Imagination green (IM)



Creativity teal (CR)



Zen (ZN)

Solid trays (color)



Blue (BU)



Green (GR)

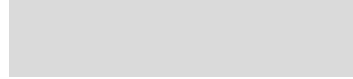

Light Gray (LG)



Red (RD)



Pastel Orange (PO)



Pastel Blue (PB)



Pastel Green (PG)



Pastel Lilac (PL)



Yellow (YW)

Crystal trays (glass-like transparency)

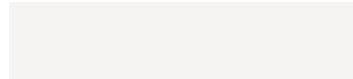

Clear (CR)



Neon Green (NG)



Neon Orange (NO)



Tinted Blue (TB)



Tinted Purple (TP)

Notes

Custom RAL color available with 15% upcharge

Stash and Cubby tops



Tier 1 laminate



Designer White (DW)



Highrise (HR)



Titanium Ev (TE)



Pewter Brush (PB)



Kensington Maple (KM)



Sterling Ash (SA)



North Sea (NS)



Black (BL)

Tier 2 laminate

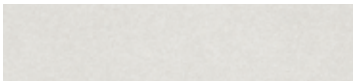

Shadow Zephyr (SZ)



Dove Grey (DG)

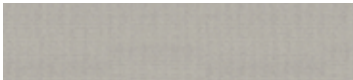

Pressed Linen (PL)



Graphite Nebula (GN)



Grey Elm (GE)



Beigewood (BW)

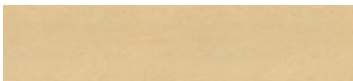

Fusion Maple (FM)



Asian Night (AN)

Tier 3 laminate

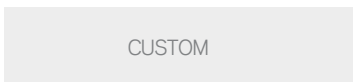

CUSTOM

Custom Laminate (CL)



Whiteboard



Wilsonart

Wilsonart Premium



FORMICA

Formica



PIONITE
DECORATIVE SURFACES

Pionite



NEVAMAR
DECORATIVE SURFACES

Nevamar

Stash trays



Solid trays (color)



Blue (BU)



Green (GR)



Light Gray (LG)



Red (RD)



Pastel Orange (PO)



Pastel Blue (PB)



Pastel Green (PG)



Pastel Lilac (PL)



Yellow (YW)

Crystal trays (glass-like transparency)

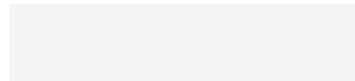

Clear (CR)



Neon Green (NG)



Neon Orange (NO)



Tinted Blue (TB)



Tinted Purple (TP)



Colors



Yellow (YW)



Blue (BU)



White (WH)



Red (RD)



Pink (PK)

Colors



Velvet Purple (PU)



Royal Blue (RB)



Sky Blue (SK)



Lime Green (GR)



Banana Yellow (BY)



Mandarin Orange (OR)



Red (R)



Night Gray (NI)



Cool Gray (CG)



Colors



Velvet Purple (PU)



Royal Blue (RB)



Sky Blue (SK)



Lime Green (GR)



Banana Yellow (BY)



Mandarin Orange (OR)



Red (R)



Night Gray (NI)



White (WH)



Black (BK)



Cool Gray (CG)



Table



Night Gray (NI)

Linking device



Night Gray (NI)

Groove



Velvet Purple (PU)



Royal Blue (RB)



Sky Blue (SK)



Lime Green (GR)



Banana Yellow (BY)



Mandarin Orange (OR)



Red (R)



Night Gray (NI)



White (WH)



Black (BK)

Space Chicken and Space Chicken XL 

Daywalker 

Table top



RAL Signal White



RAL Signal Black

Table top



RAL Signal White



RAL Signal Black

Base finishes



RAL Signal White



RAL Signal Black

Base finishes



RAL Signal White



RAL Signal Black



Solid ash frame



Clear (CL)



White (WH)



Black (BL)

Standard shell



Light gray (LG)



Dark gray (DG)

Bespoke shell



Dark green (DG)



Dark blue (DU)



Brown (BR)



Beige (BE)



Pink (PI)



Olive (OL)



Standard frame



White (WH)



Black (BL)

Bespoke frame



Red (RD)



Blue (BU)



Yellow (YW)



Gray (GR)

Standard shell



Light gray (LG)

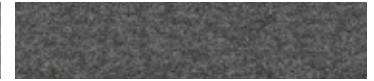

Dark gray (DG)

Bespoke shell



Dark green (DN)



Dark blue (DU)



Brown (BR)



Beige (BE)



Pink (PI)



Olive (OL)



Standard frame



White (WH)



Black (BL)

Bespoke frame



Red (RD)



Blue (BU)



Yellow (YW)



Gray (GR)

Standard shell



Light gray (LG)

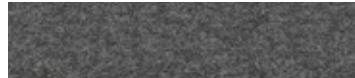

Dark gray (DG)

Bespoke shell

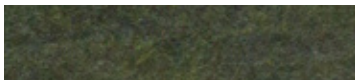

Dark green (DG)



Dark blue (DU)



Brown (BR)

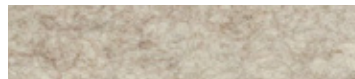

Beige (BE)



Pink (PI)



Olive (OL)



Standard frame



White (WH)



Black (BL)

Bespoke frame



Red (RD)



Blue (BU)



Yellow (YW)



Gray (GR)

Standard shell



Light gray (LG)



Dark gray (DG)

Bespoke shell



Dark green (DG)



Dark blue (DU)



Brown (BR)



Beige (BE)



Pink (PI)



Olive (OL)



Standard frame



White (WH)



Black (BL)

Bespoke frame



Red (RD)



Blue (BU)



Yellow (YW)



Gray (GR)

Standard shell



Light gray (LG)



Dark gray (DG)

Bespoke shell



Dark green (DG)



Dark blue (DU)



Brown (BR)



Beige (BE)



Pink (PI)



Olive (OL)

Back



Black (BL)



White (WH)

Seat fabric



Black (BL)



Blue (BU)



Green (GN)



Orange (OR)

Frame



Black (BL)

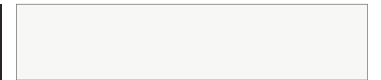

Silver (SI)



Eco Colors



Optimism yellow (OP)



Collaboration orange (CO)



Passion red (PS)



Imagination green (IM)



Creativity teal (CR)



Zen (ZN)



Humanity (HM)

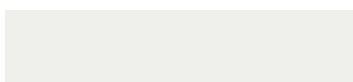

Peace (PE)



Balance (BA)

Eco Colors



Optimism yellow (OP)



Collaboration orange (CO)



Passion red (PS)



Imagination green (IM)



Creativity teal (CR)



Zen (ZN)



Humanity (HM)

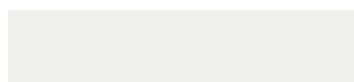

Peace (PE)



Balance (BA)

Notes

Custom RAL color available with 15% upcharge

Notes

Custom RAL color available with 15% upcharge



Eco Colors



Optimism yellow (OP)



Collaboration orange (CO)



Passion red (PS)



Imagination green (IM)



Creativity teal (CR)



Zen (ZN)



Humanity (HM)

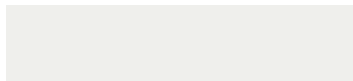

Peace (PE)



Balance (BA)

Top



Solid Iroko

Notes

Custom RAL color available with 15% upcharge

Custom wood tops are available for this product such as ply, laminate and butcher block. Please get in touch for more information.

Eco Colors



Optimism yellow (OP)



Collaboration orange (CO)



Passion red (PS)



Imagination green (IM)



Creativity teal (CR)



Zen (ZN)



Humanity (HM)

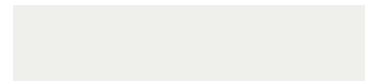

Peace (PE)



Balance (BA)

Top



Solid Iroko

Notes

Custom RAL color available with 15% upcharge

Custom wood tops are available for this product such as ply, laminate and butcher block. Please get in touch for more information.



Eco Colors

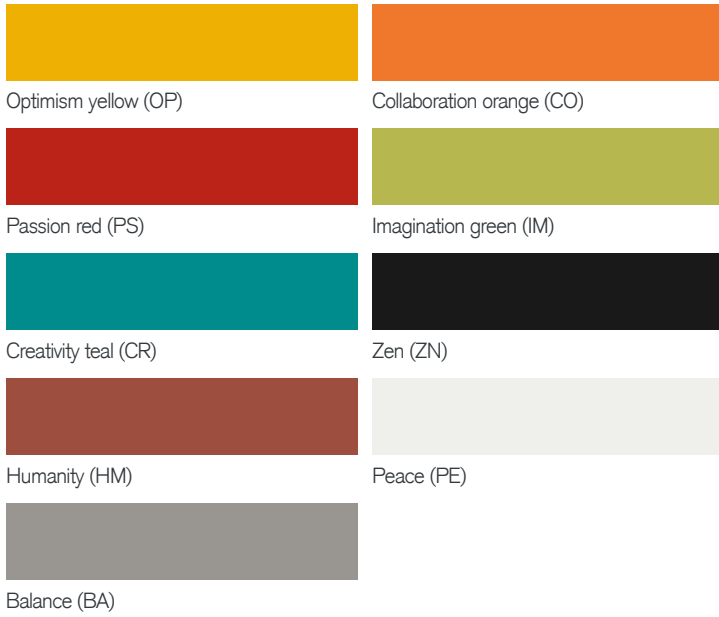

Eco Colors

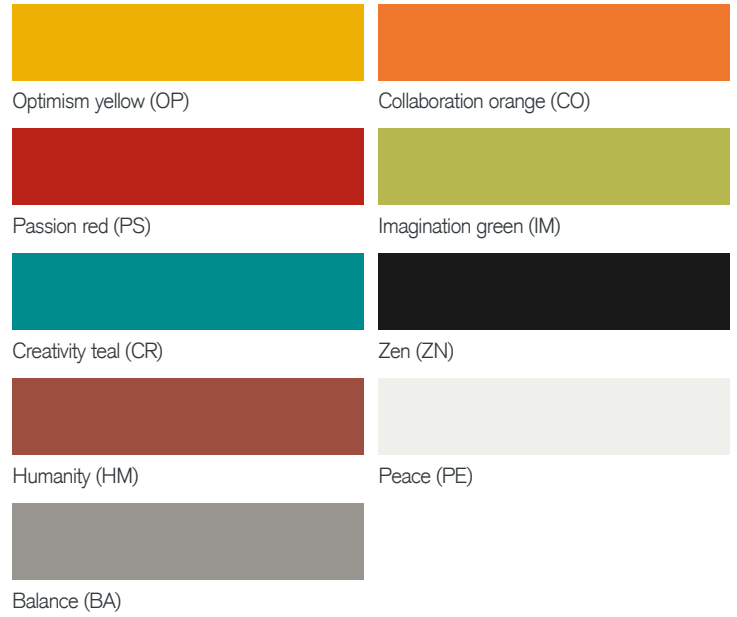

Notes

Custom RAL color available with 15% upcharge

Notes

Custom RAL color available with 15% upcharge

Custom wood tops are available for this product such as ply, laminate and butcher block. Please get in touch for more information.

Box Planter



Eco Colors



Optimism yellow (OP)



Collaboration orange (CO)



Passion red (PS)



Imagination green (IM)



Creativity teal (CR)



Zen (ZN)



Humanity (HM)



Peace (PE)



Balance (BA)

Notes

Custom RAL color available with 15% upcharge

Custom wood tops are available for this product such as ply, laminate and butcher block. Please get in touch for more information.

Drum Planter



Eco Colors



Optimism yellow (OP)



Collaboration orange (CO)



Passion red (PS)



Imagination green (IM)



Creativity teal (CR)



Zen (ZN)



Humanity (HM)



Peace (PE)



Balance (BA)

Notes

Custom RAL color available with 15% upcharge



Eco Colors



Optimism yellow (OP)



Collaboration orange (CO)



Passion red (PS)



Imagination green (IM)



Creativity teal (CR)



Zen (ZN)



Humanity (HM)



Peace (PE)



Balance (BA)

Eco Colors



Optimism yellow (OP)



Collaboration orange (CO)



Passion red (PS)



Imagination green (IM)



Creativity teal (CR)



Zen (ZN)



Humanity (HM)



Peace (PE)



Balance (BA)

Notes

Custom RAL color available with 15% upcharge

Custom wood tops are available for this product such as ply, laminate and butcher block. Please get in touch for more information.

Notes

Custom RAL color available with 15% upcharge



Eco Colors

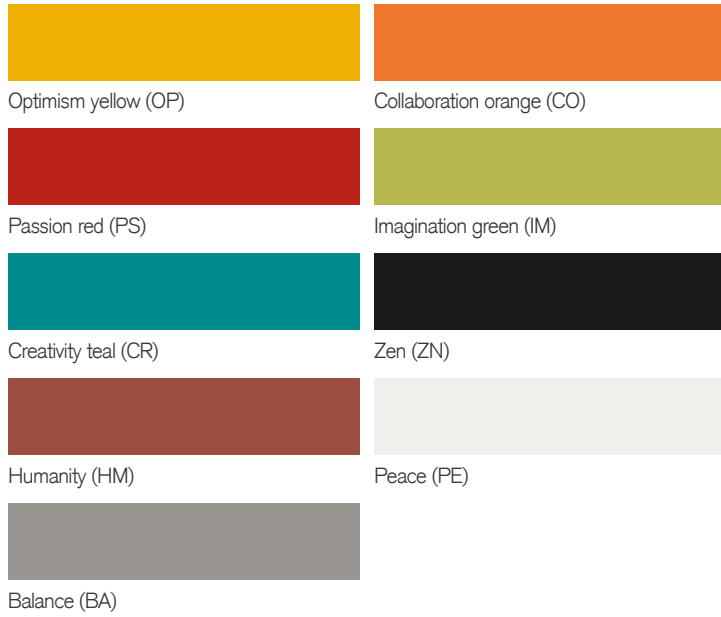

Eco Colors

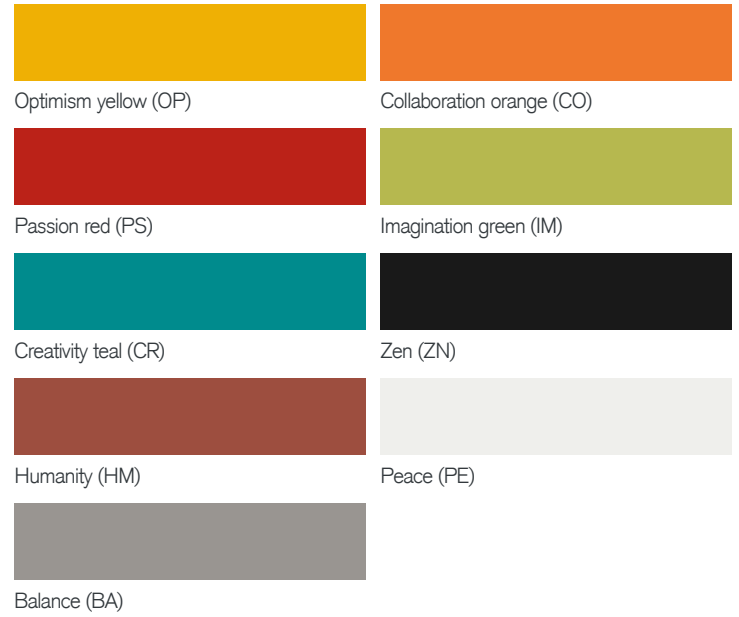

Notes

Custom RAL color available with 15% upcharge

Notes

Custom RAL color available with 15% upcharge

Tall Tri Stool



Eco Colors



Optimism yellow (OP)



Collaboration orange (CO)



Passion red (PS)



Imagination green (IM)



Creativity teal (CR)



Zen (ZN)



Humanity (HM)



Peace (PE)



Balance (BA)

Notes

Custom RAL color available with 15% upcharge

Trestle



Eco Colors



Optimism yellow (OP)



Collaboration orange (CO)



Passion red (PS)



Imagination green (IM)



Creativity teal (CR)



Zen (ZN)



Humanity (HM)



Peace (PE)



Balance (BA)

Notes

Custom RAL color available with 15% upcharge

Town



Colors



White



Anthracite



Yellow



Bordeaux



Dove Gray



English Green

Java



Top



Designer White (DW)

Base



Silver

Eco Colors



Optimism yellow (OP)



Collaboration orange (CO)



Passion red (PS)



Imagination green (IM)



Creativity teal (CR)



Zen (ZN)



Humanity (HM)

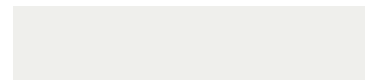

Peace (PE)



Balance (BA)

Notes

Custom RAL color available with 15% upcharge

Love Seat



Standard Colors



Black

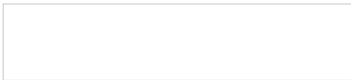

White



Terracotta



Deep Blue

Hot Seat



Standard Colors



Black

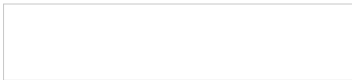

White



Terracotta



Deep Blue



Standard Colors



Black

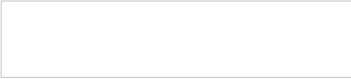

White



Terracotta



Deep Blue



Frame Color



Black (BL)

Colors



Black (BL)



Light Gray (LG)



Orange (OR)



Yellow (YE)



Green (GN)



Ocean (OC)



Blue (BU)



Magenta (MA)



Red (RD)



Standard finishes



Oyster



Alpine Stone



Charcoal Tweed

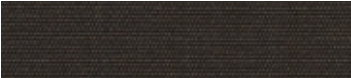

Black

Special order finishes



Natural



Storm



Charcoal



Slate



Linen



Taupe



Fern



Terracotta



Sunflower Yellow

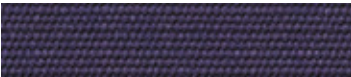

Captain Navy