

General

Uses

Residential | Canteens | Terraces | Gardens

Warranty

5 years

Return policy

Full payment will still be required for orders cancelled after 7 days.

Materials

Polyester powder-coated aluminum

Code

PINGPONG/IN	Indoor
PINGPONG/OUT	Outdoor

Options

Non-standard colors.

Bolt-down brackets (fixings not supplied).

Installation

Assembly is required for this product.

Instructions, diagrams and fixings are supplied.

Please be careful when removing wrapping to avoid sharp implements damaging the surface.





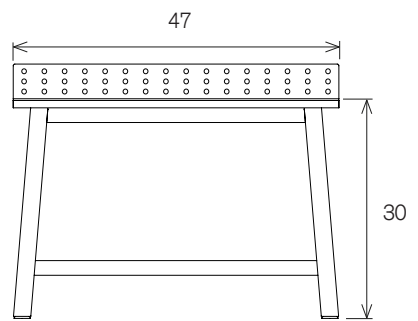
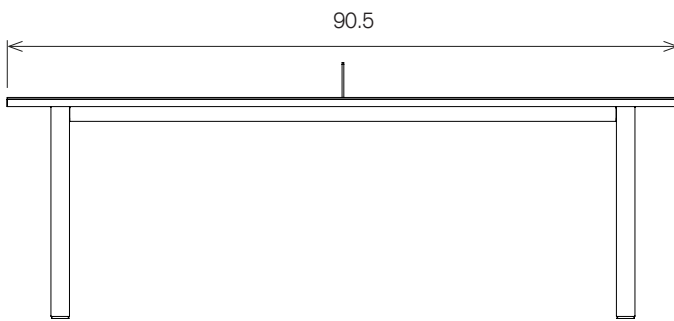



Dimensions & Weight

Table	Width	Depth	Height	Weight
PINGPONG/IN	90.5"	47"	30"	177 lbs
PINGPONG/OUT	90.5"	47"	30"	177 lbs

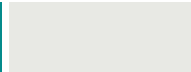

Finishes

Muzo Eco
Powder coat

				
Passion PS/ECO	Humanity HM/ECO	Collaboration CO/ECO	Optimism OP/ECO	Imagination IM/ECO
				
Creativity CR/ECO	Peace PE/ECO	Balance BA/ECO	Zen ZN/ECO	

*RAL colors available as special request

Contact info

Inquiries

hello@muzo-works.com

Purchase orders

sales@muzo-works.com

360 Kiwanis Blvd,
West Hazleton, PA 18202

(800) 670-2578

muzo-works.com