

General

Uses

Residential | Canteens | Terraces | Gardens

Warranty

5 years

Return policy

Full payment will still be required for orders cancelled after 7 days.

Materials

Polyester powder-coated aluminum.

Code

Linear/	Table
Linear/Bench1/	Bench
Linear/Bench2/	Bench with back support

Options

RAL Non-standard colours.
In-frame weighting.

Environmental

FISP accredited
100% recyclable
Durable materials

Installation

Assembly is not required for this product.
Check access to ensure this one piece product can be installed without difficulty.
Please be careful when removing wrapping to avoid sharp implements damaging the surface.

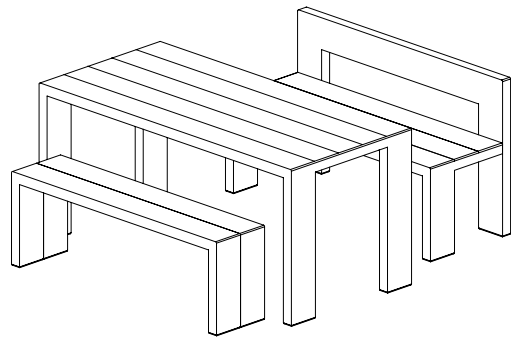

Dimensions & Weight

Table	Width	Depth	Height	Weight
Linear/	63"	30"	29.5"	88 lbs



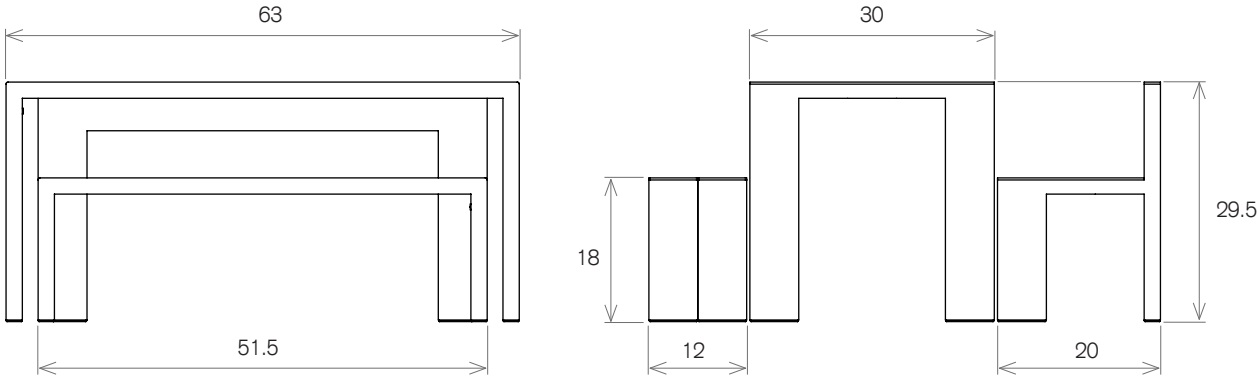



Bench	Width	Depth	Height	Weight
Linear/Bench1/	51.5"	12"	18"	44 lbs
Linear/Bench2/	51.5"	20"	29.5"	57lbs



Seats 3

Finishes

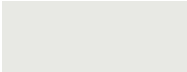
Muzo Eco
Powder coat

				
Passion PS/ECO	Humanity HM/ECO	Collaboration CO/ECO	Optimism OP/ECO	Imagination IM/ECO
				
Creativity CR/ECO	Peace PE/ECO	Balance BA/ECO	Zen ZN/ECO	

*RAL colors available as special request

Contact info

Inquiries

hello@muzo-works.com

Purchase orders

sales@muzo-works.com

360 Kiwanis Blvd,
West Hazleton, PA 18202

(800) 670-2578

muzo-works.com