

Kite[®] muZO



A mobile, flip-top folding table system that makes life easy.



The vast number of configurations that can be achieved with Kite tables enables users to tailor an area in the moment, to suit their needs and to support interactions, for all, during presentations. Personal space of 30 inch is achieved no matter which layout you create.

Kite is more than a table system, it is a dynamic, fluid, business tool. You can add tables to expand when needed, rearrange them in seconds whenever called for, efficiently store/nest them when required and even level tables on uneven floors.





Learning



Wirelessly powered meetings



Higher Education



Meeting & Training



Classroom



Easy to fold and move



Simple nesting



Wirelessly powered gatherings

Performance points



Jewel caster

The caster ensures Kite can perform like fixed-frame tables when the breaks are engaged. The dual-locking mechanism prevents the wheels rolling and twisting.

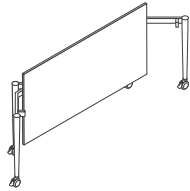

Narrow profile when folded

When in transit, the tables can fit through narrow doorways or corridors.

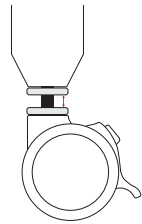

Levelling

2 inch of levelling potential ensures the table-tops meet flush on uneven floors.

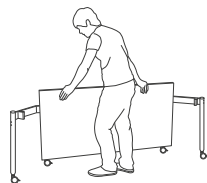

Inclusive usability

Kite tables can be quickly and easily assembled by one person - no heavy lifting and no need for a trolley

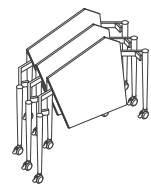

Nesting

Kite tables are easily folded, moved and nested allowing you to make the most of your available space.

Accessories



Modesty panel

Modesty panels can be fitted to all Kite tables and are available in matching finishes or in perforated steel. Modesty panels can be easily removed or added to tables at any



Power and data

A range of soft wired power and data units can be fitted to all Kite table systems.



Cable management

A range of cable management products can be used to neatly accommodate cables into the Kite table systems.

Possible uses and layouts

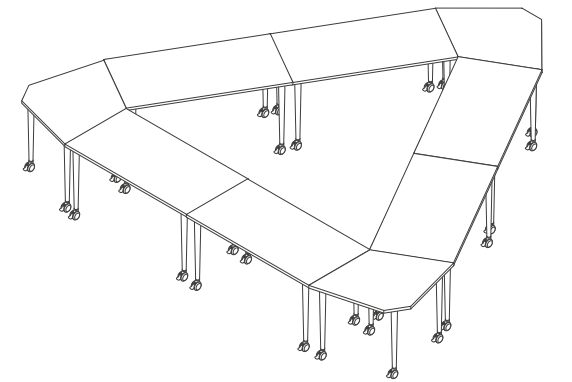
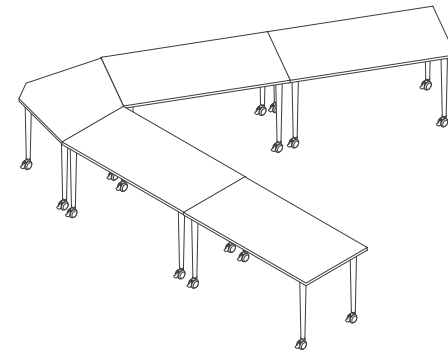
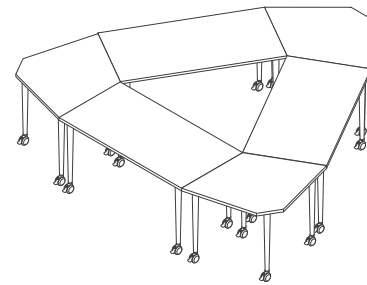
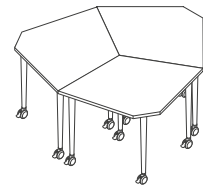
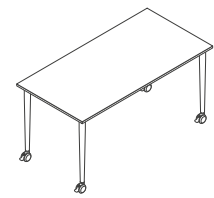
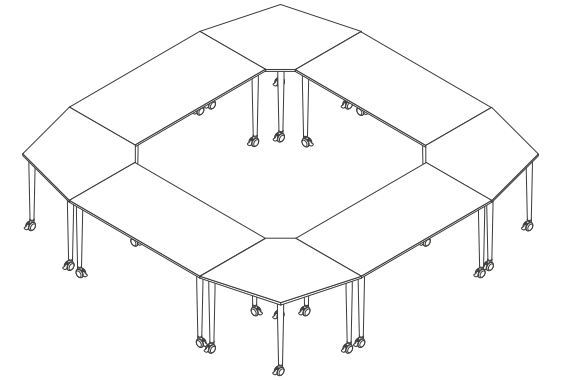
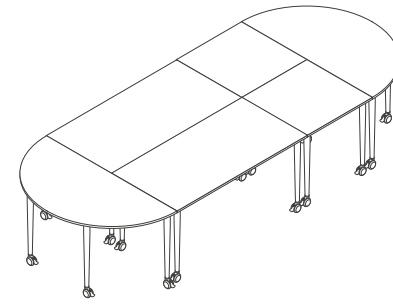
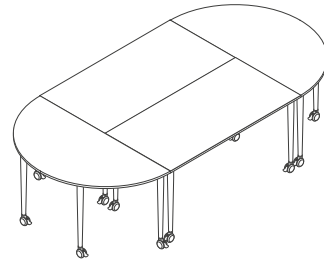
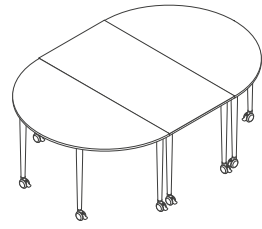
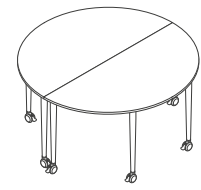
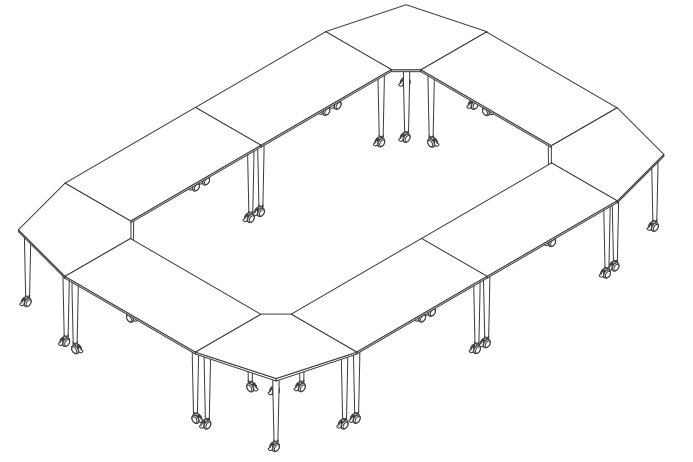
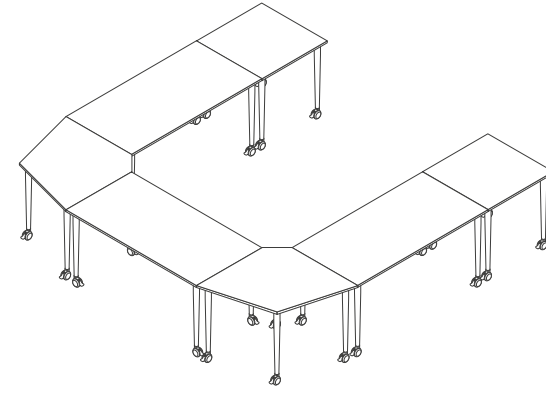
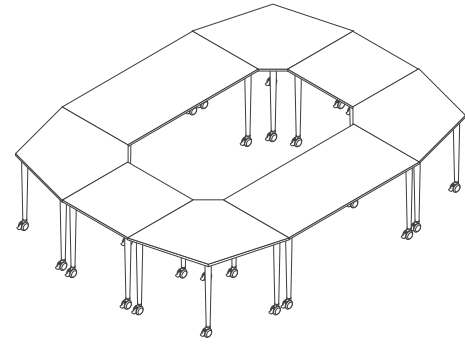
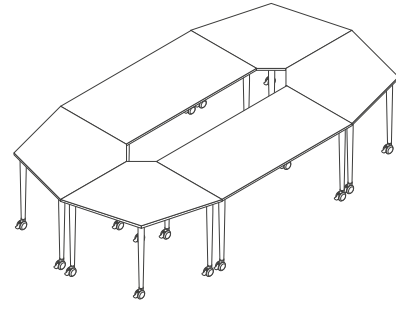
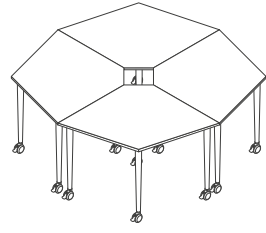

Dimensions

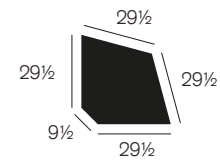

750 Kite

table top

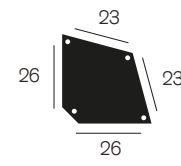

space between legs

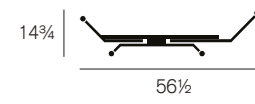

folded

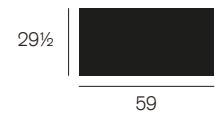

750 Rectangle

table top

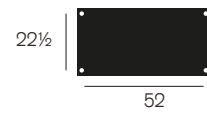

space between legs

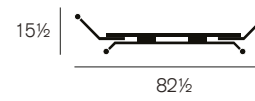

folded

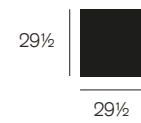

750 Square

table top

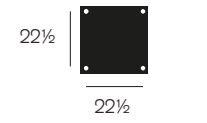

space between legs

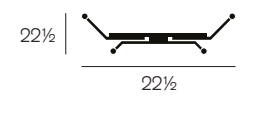

folded

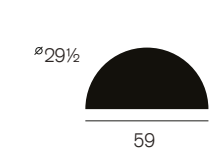

750 Semi-circle

table top

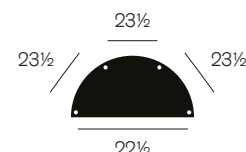

space between legs

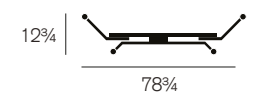

folded

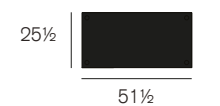

650 Rectangle

table top

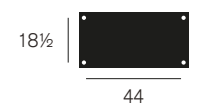

space between legs

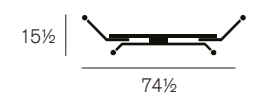

folded

Nested dimensions

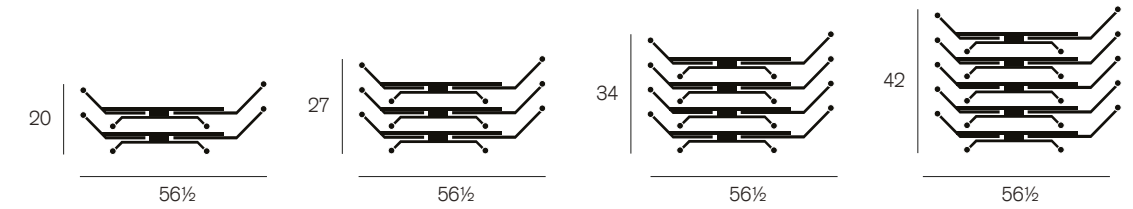

750 Kite

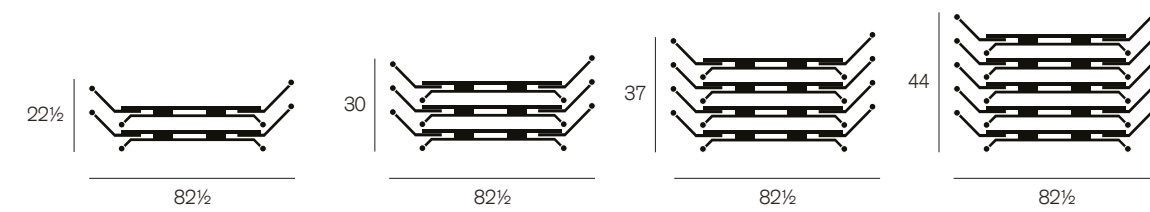

750 Rectangle

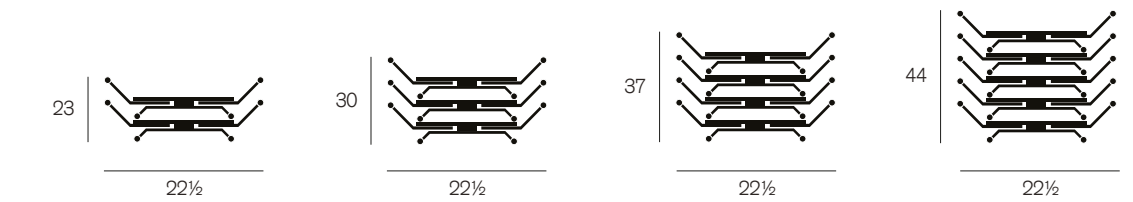



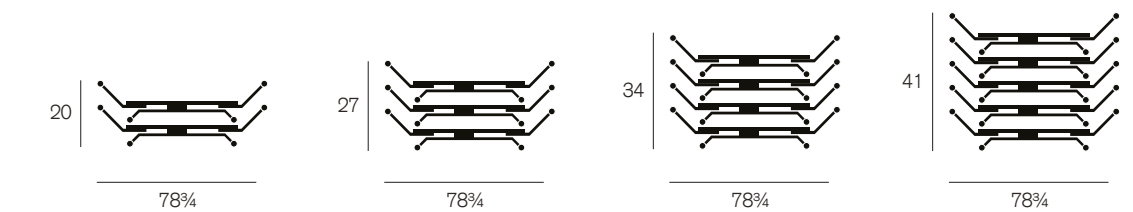









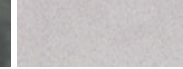

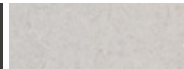

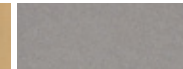
750 Square



750 Semi-circle

Materials

Table top finishes

Tier 1					
	Designer White DW	Kensington Maple KM	Pewter Brush PB	Titanium Ev TE	Wild Cherry WC
Tier 2					
	Black BL	White Tigris WT	Fusion Maple FM	Misted Zephyr MZ	Dove Grey DG
					
	Bannister Oak BO	Fonthill Pear FP	Hibiscus Cherry HC	Graphite Nebula GN	
Tier 3					
	Whiteboard	Wilsonart premium	Formica	Pionite	Nevamar

Materials

Leg finishes

Standard				
	Silver (SS)	Graphite (SGR)	Black (SBL)	White (SWH)
				
	Chrome (SCH)	Tapered Silver (TSL)		
Eco Powdura Colors				
	Optimism yellow (OY)	Collaboration orange (CO)	Passion red (PR)	Imagination green (IG)
				
	Creativity teal (CT)	Black (BL)		

For more information visit muzo-works.com
or call us on (800) 670-2578.

muzo

360 Kiwanis Blvd,
West Hazleton, PA 18202

(800) 670-2578
sales@muzo-works.com

muzo-works.com