

General

Minimum order quantity

20

Test certificates

BIFMA

Greenguard

TUV

GS

Warranty

Full 5 years guarantee when used in a standard 8hr/day environment (excluding upholstery, expendable spare parts on 1 year and replaceable materials on 2 years). When used in a 24/7 environment the guarantee is reduced to 2 years.

Return policy

Order cancellation permitted before product ships subject to \$75-100 re-stocking fee per product.

Casters

The casters are categorized as type H and suitable for carpeted floors.

Nesting capability

Seat flips up to create space for nesting

Max user weight

249 lbs

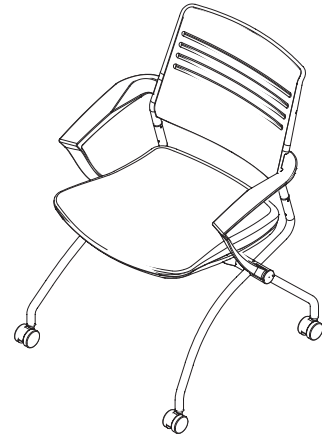

Dimensions

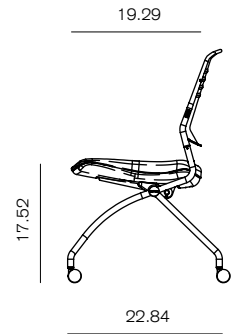
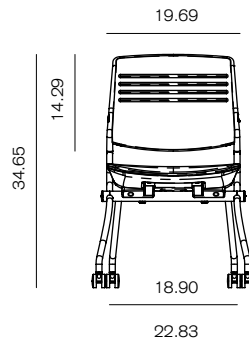
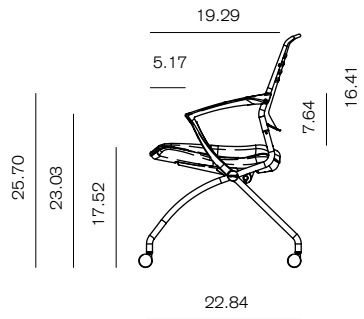
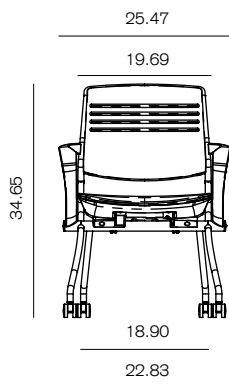
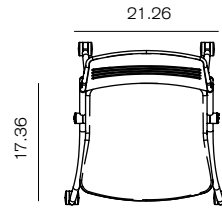
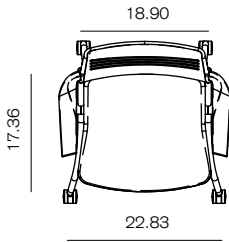

with armrest

without armrest

Nested dimensions

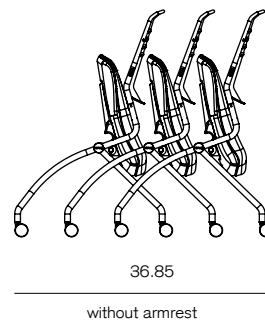
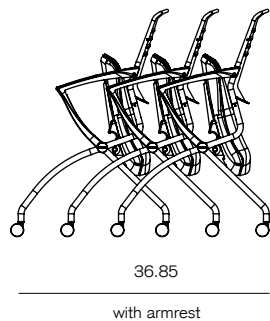

Finishes

Back



Black (BL)



White (WH)

Seat fabric



Black (BL)



Blue (BU)



Green (GN)



Orange (OR)

Frame



Black (BL)



Silver (SI)

*Finishes may differ slightly from images shown - samples can be provided on request

Packaged dimensions and weights

Switch chair with arms

- Box: 37.5 x 27.5 x 29.5 inch Weight: 64 lbs

Switch chair without arms

- Box: 37.5 x 27.5 x 22 inch Weight: 53 lbs

Chair weights (total net weight)

Switch chair with arms

57.5 lbs

Switch chair without arms

48.5 lbs

Material information

Material type	Chair component	Recycled content	Recyclable after use
Plastic (44%)	<ul style="list-style-type: none"> • Back • Seat frame • Armrest • Seat buffer & spacer • Casters 	0%	98.5% Recyclable
Steel (47.2%)	<ul style="list-style-type: none"> • Frame • Black stick • Screws & bolts 	0%	98.5% Recyclable
Foam (7.3%)	<ul style="list-style-type: none"> • PU Seat Foam 	0%	98.5% Recyclable
Upholstery (1.5%)	<ul style="list-style-type: none"> • Upholstery fabric 	0%	1.8% Non-Recyclable

Contact info

Inquiries

hello@muzo-works.com

Purchase orders

sales@muzo-works.com

360 Kiwanis Blvd,
West Hazleton, PA 18202

muzo-works.com