

General

Minimum order quantity

20

Test certificates

BIFMA

Greenguard

TUV

GS

Warranty

Full 5 years guarantee when used in a standard 8hr/day environment (excluding upholstery, expendable spare parts on 1 year and replaceable materials on 2 years). When used in a 24/7 environment the guarantee is reduced to 2 years.

Return policy

Order cancellation permitted before product ships subject to \$75-100 re-stocking fee per product.

Casters

The casters are categorized as type H and suitable for carpeted floors.

Nesting capability

Seat flips up to create space for nesting

Max user weight

249 lbs

Codes

SW/NOARM Switch chair without armrest

SW/ARM Switch chair with armrest

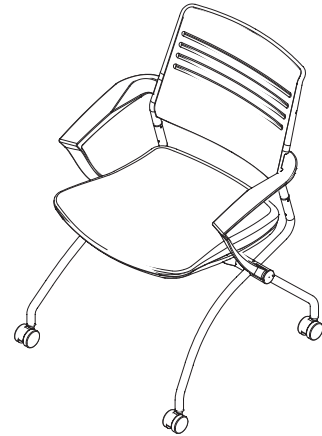

Dimensions

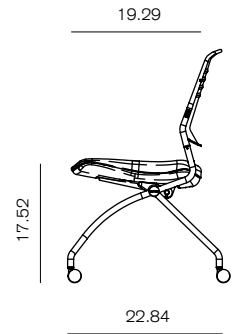
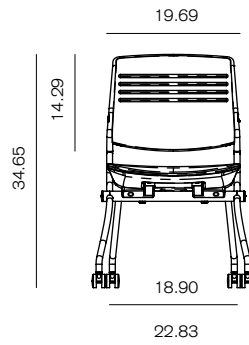
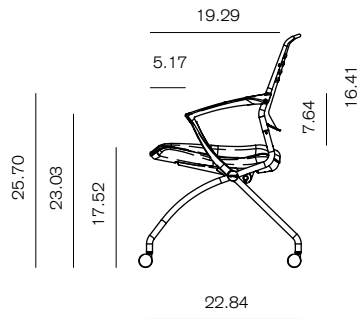
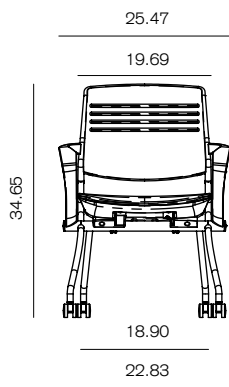
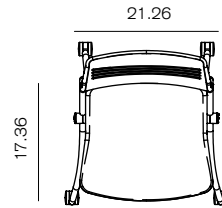
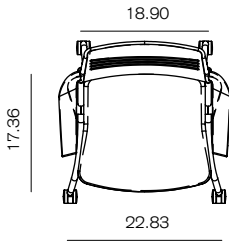

with armrest

without armrest

Nested dimensions

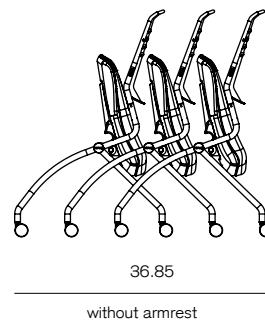
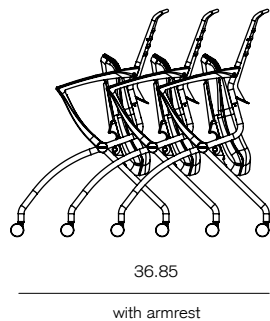

Active Back finishes



Black (BL)

White (W)

Fabric colours (100% polyester)



Black (BL)

Blue (B)

Green (G)

Orange (O)

Frame finishes



Black (BL)

Silver (SSL)

Material information

Material type	Chair component	Recycled content	Recyclable after use
Plastic (44%)	<ul style="list-style-type: none"> • Back • Seat frame • Armrest • Seat buffer & spacer • Casters 	0%	98.5% Recyclable
Steel (47.2%)	<ul style="list-style-type: none"> • Frame • Black stick • Screws & bolts 	0%	98.5% Recyclable
Foam (7.3%)	<ul style="list-style-type: none"> • PU Seat Foam 	0%	98.5% Recyclable
Upholstery (1.5%)	<ul style="list-style-type: none"> • Upholstery fabric 	0%	1.8% Non-Recyclable

*Finishes may differ slightly from images shown - samples can be provided on request

Packaged dimensions and weights

Switch chair with arms

- Box: 37.5 x 27.5 x 29.5 inch Weight: 64 lbs

Switch chair without arms

- Box: 37.5 x 27.5 x 22 inch Weight: 53 lbs

Chair weights (total net weight)

Switch chair with arms

57.5 lbs

Switch chair without arms

48.5 lbs

Container information

Switch chair with arms

20' = 139 pcs

40' = 279 pcs

40' HQ = 335 pcs

Switch chair without arms

20' = 174 pcs

40' = 349 pcs

40' HQ = 419 pcs

Contact info

Inquiries

hello@muzo-works.com

Purchase orders

sales@muzo-works.com

360 Kiwanis Blvd,
West Hazleton, PA 18202

muzo-works.com