

## General

---

### Minimum order quantity

20

### Test certificates

BIFMA

Greenguard

TUV

GS

### Warranty

Full 5 years guarantee when used in a standard 8hr/day environment (excluding upholstery, expendable spare parts on 1 year and replaceable materials on 2 years). When used in a 24/7 environment the guarantee is reduced to 2 years.

### Return policy

Order cancellation permitted before product ships subject to \$75-100 re-stocking fee per product.

### Casters

The casters are categorized as type H and suitable for carpeted floors.

### Nesting capability

Seat flips up to create space for nesting

### Max user weight

249 lbs

### Codes

SW/NOARM      Switch chair without armrest

SW/ARM         Switch chair with armrest

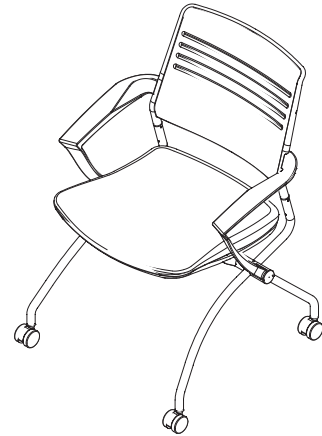

## Dimensions

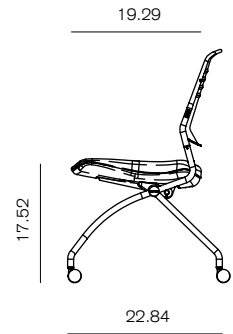
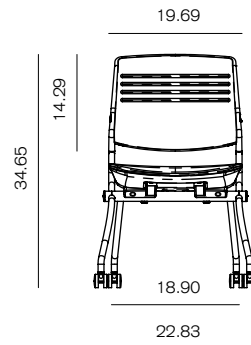
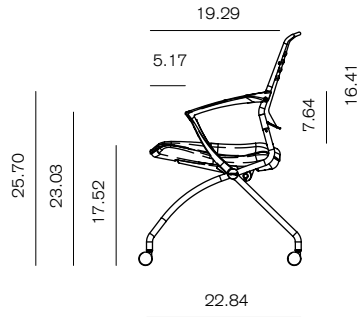
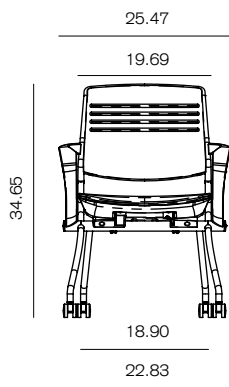
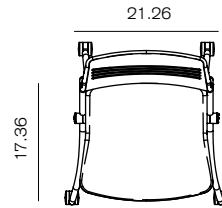
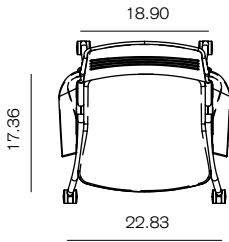

with armrest

without armrest

## Nested dimensions

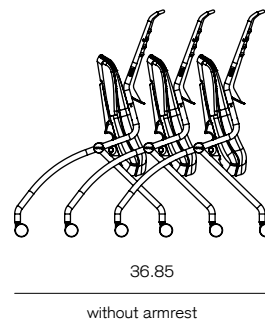
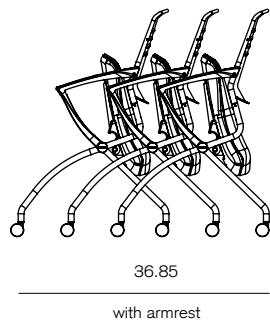

### Active Back finishes



Black (BL)    Dark Gray (DG)    Light Gray (LG)

### Fabric colours (100% polyester)



Black (BL)    Gray (G)    Red (R)    Blue (B)

### Frame finishes



Black (BL)    Silver (SSL)



Green (G)    Orange (O)

### Material information

Material type	Chair component	Recycled content	Recyclable after use
Plastic (44%)	<ul style="list-style-type: none"> <li>• Back</li> <li>• Seat frame</li> <li>• Armrest</li> <li>• Seat buffer &amp; spacer</li> <li>• Casters</li> </ul>	0%	98.5% Recyclable
Steel (47.2%)	<ul style="list-style-type: none"> <li>• Frame</li> <li>• Black stick</li> <li>• Screws &amp; bolts</li> </ul>	0%	98.5% Recyclable
Foam (7.3%)	<ul style="list-style-type: none"> <li>• PU Seat Foam</li> </ul>	0%	98.5% Recyclable
Upholstery (1.5%)	<ul style="list-style-type: none"> <li>• Upholstery fabric</li> </ul>	0%	1.8% Non-Recyclable

\*Finishes may differ slightly from images shown - samples can be provided on request

## Packaged dimensions and weights

### Switch chair with arms

- Box: 37.5 x 27.5 x 29.5 inch    Weight: 64 lbs

### Switch chair without arms

- Box: 37.5 x 27.5 x 22 inch    Weight: 53 lbs

## Chair weights (total net weight)

### Switch chair with arms

57.5 lbs

### Switch chair without arms

48.5 lbs

## Container information

### Switch chair with arms

20' = 139 pcs

40' = 279 pcs

40' HQ = 335 pcs

### Switch chair without arms

20' = 174 pcs

40' = 349 pcs

40' HQ = 419 pcs

Contact info

---

Inquiries

[hello@muzo-works.com](mailto:hello@muzo-works.com)

Purchase orders

[sales@muzo-works.com](mailto:sales@muzo-works.com)

72 Hillside Drive, Drums,  
PA 18222, USA

(570) 788 0888

[muzo-works.com](http://muzo-works.com)