

General

Minimum order quantity

None

Test certificates

SATRA

Patents

6164217 Gate Leg Folding Table

6158358 Kite Shape Table

Warranty

Separate sheet

Return policy

Order cancellation permitted before product ships subject to \$75-100 re-stocking fee per product

Once product ships no returns unless covered by warranty (due to custom nature of the tables)

Materials

Table-top: Particle board substrate with laminate finish

Frame: Powder-coated steel

Legs: Powder-coated tubular steel

Caster: Rubber and plastic

Codes

KTK/75 Kite Shape

KTR/75150 59" x 29.5" Rectangle

KTS/7575 29.5" x 29.5" Square







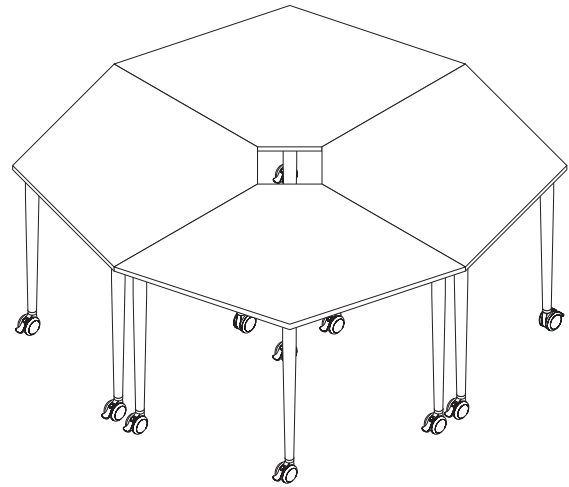

KTSC/75150 59" x 29.5" Semi Circle

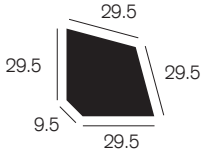
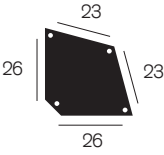
Casters

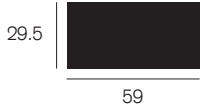
Kite features Jewel caster, a patent-pending caster which locks both the wheel and axis for maximum stability.

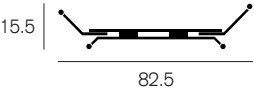

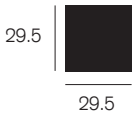
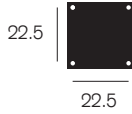
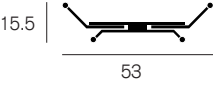
Dimensions

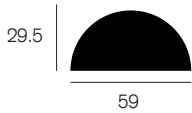
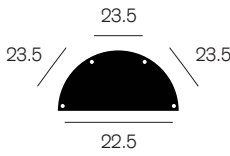
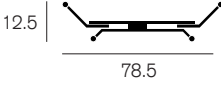
	Top	Space between table legs	Folded
<p>750 Kite</p> 			
<p>750 Rectangle</p> 			
<p>750 Square</p> 			
<p>750 Semi-circle</p> 			



25" from floor to underside of frame on all tables
(with casters set to lowest point)

Nested dimensions















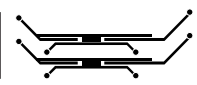
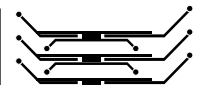

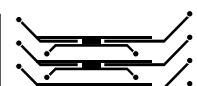
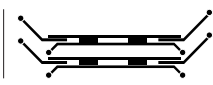
750 Kite	750 Rectangle	750 Square	750 Semi-circle
			
<p>20 </p> <p>27 </p> <p>34 </p> <p>42 </p> <p style="text-align: center;">56.5</p>	<p>22½ </p> <p>30 </p> <p>37 </p> <p>44 </p> <p style="text-align: center;">82.5</p>	<p>23 </p> <p>30 </p> <p>37 </p> <p>44 </p> <p style="text-align: center;">53</p>	<p>20 </p> <p>27 </p> <p>34 </p> <p>41 </p> <p style="text-align: center;">78½</p>

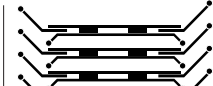
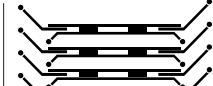
Table weights (Assembled)

750 Range

Kite shape: 65 lbs

59" x 29.5" Rectangle: 75lbs

29.5" x 29.5" Square: 55lbs

59" x 29.5" Semi-circle: 70lbs

Packaged dimensions and weights

750 Kite shape:

- Box 1: H: 6" L: 39" W: 39" Weight: 50lbs

- Box 2: H: 4.5" L: 29" W: 9.5" Weight: 17lbs

750 Rectangle shape:

- Box 1: H: 6" L: 61" W: 33" Weight: 75lbs

- Box 2: H: 4.5" L: 29" W: 9.5" Weight: 17lbs

750 Square shape:

- Box 1: H: 6" L: 33" W: 33" Weight: 40lbs

- Box 2: H: 4.5" L: 29" W: 9.5" Weight: 17lbs

750 Semi-circle shape:

- Box 1: H: 6" L: 61" W: 33" Weight: 70lbs

- Box 2: H: 4.5" L: 29" W: 9.5" Weight: 17lbs

Shipping details

Freight carrier

A. Duie Pyle – East Coast

(ME, VT, NH, MA, RI, NY, NJ, PA, DE, MD, DC

(OH, WV, VA partial)

R+L Carriers – all other contiguous U.S. States

Third party shipping options

Available on request

Table tops

Top thickness: ¾"

Finish options: Wilsonart standard finish options, options with additional charge, other finish options such as Pionite, Nevamar, Formica available on request.

Edge options for laminate: 3mm PVC (standard)
Other (2mm PVC, 3mm ABS, 2mm ABS), Urethane

Legs

Legs: Straight (standard) or Tapered

Leg finish: Silver, Graphite, Chrome
Other finish options available on request

Standard leg finishes*



Graphite (GR) Silver (SSL) Chrome (CH)

Tier 1 top finishes*



Designer White DW Kensington Maple Pewter Brush PB Titanium Ev TE



Wild Cherry WC

Tier 3 top finishes*

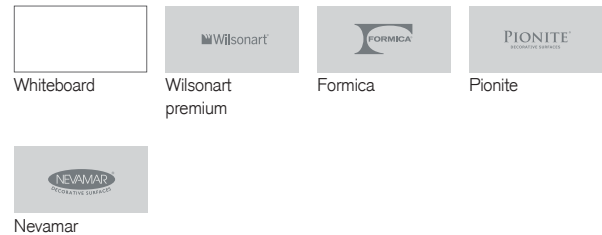

Whiteboard Wilsonart premium Formica Pionite Nevamar

Tier 2 top finishes*

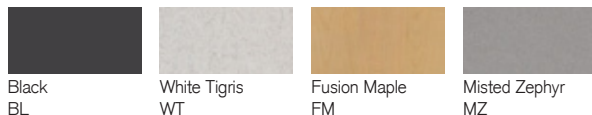

Black BL White Tigris WT Fusion Maple FM Misted Zephyr MZ



Dove Grey DG Bannister Oak BO Fonthill Pear FP Hibiscus Cherry HC



Graphite Nebula GN

*Finishes may differ slightly from images shown - samples can be provided on request



Contact info

Inquiries

hello@muzo-works.com

Purchase orders

sales@muzo-works.com

360 Kiwanis Blvd,
West Hazleton, PA 18202

(800) 670-2578

muzo-works.com