

## Mini Mobile

### 1050 crescent folding table

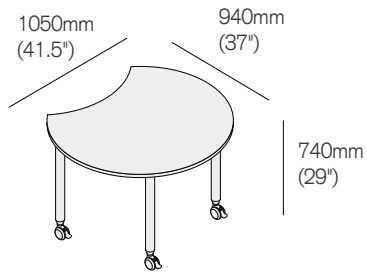

	Straight Silver Legs MMCT/105/SS	Straight Graphite Legs MMCT/105/SG	Straight Chrome Legs MMCT/105/SC	Tapered Silver Legs MMCT/105/TS
Tier 1 tops	1010	1010	1178	1304
Tier 2 tops	1111	1111	1279	1405
Tier 3 tops	1262	1262	1430	1556

## Mini Mobile

### 1050 circle folding table

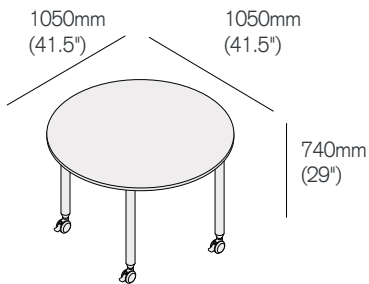

	Straight Silver Legs MMFC/105/SS	Straight Graphite Legs MMFC/105/SG	Straight Chrome Legs MMFC/105/SC	Tapered Silver Legs MMFC/105/TS
Tier 1 tops	1010	1010	1178	1304
Tier 2 tops	1111	1111	1279	1405
Tier 3 tops	1262	1262	1430	1556

## Mini Mobile

### 850 crescent folding table

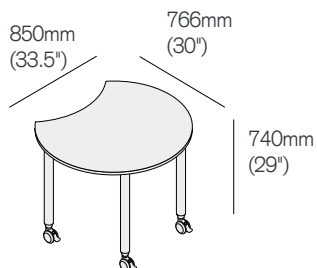

	Straight Silver Legs MMCT/85/SS	Straight Graphite Legs MMCT/85/SG	Straight Chrome Legs MMCT/85/SC	Tapered Silver Legs MMCT/85/TS
Tier 1 tops	873	873	1041	1167
Tier 2 tops	960	960	1128	1254
Tier 3 tops	1091	1091	1259	1385

## Mini Mobile

### 850 circle folding table

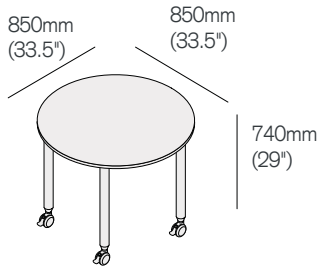

	Straight Silver Legs MMFC/85/SS	Straight Graphite Legs MMFC/85/SG	Straight Chrome Legs MMFC/85/S	Tapered Silver Legs MMFC/85/TSC
Tier 1 tops	873	873	1041	1167
Tier 2 tops	960	960	1128	1254
Tier 3 tops	1091	1091	1259	1385

## Low Mini Mobile

### Low 850 crescent folding table

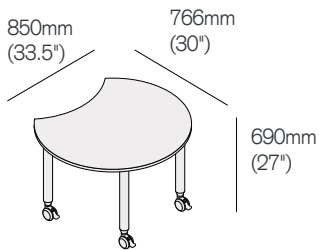

	Straight Silver Legs LMMCT/85/SS	Straight Graphite Legs LMMCT/85/SG
Tier 1 tops	873	873
Tier 2 tops	960	960
Tier 3 tops	1091	1091

## Low Mini Mobile

### Low 850 circle folding table

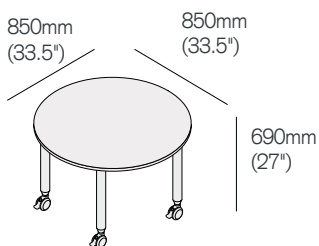

	Straight Silver Legs LMMFC/85/SS	Straight Graphite Legs LMMFC/85/SG
Tier 1 tops	873	873
Tier 2 tops	960	960
Tier 3 tops	1091	1091

## Tall Mini Mobile

### 1050 crescent folding table

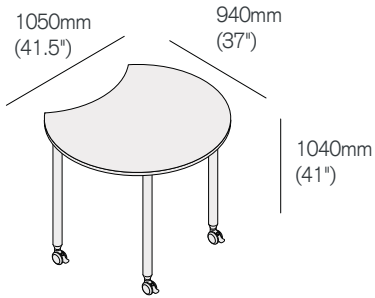

	Straight Silver Legs TMMCT/105/SS	Straight Graphite Legs TMMCT/105/SG
Tier 1 tops	1216	1216
Tier 2 tops	1317	1317
Tier 3 tops	1468	1468

## Tall Mini Mobile

### 1050 circle folding table

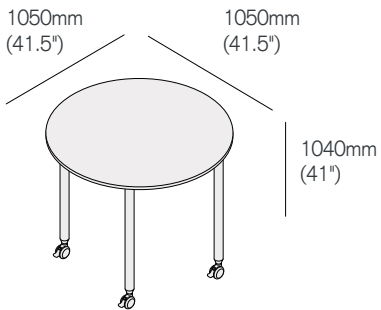

	Straight Silver Legs TMMFC/105/SS	Straight Graphite Legs TMMFC/105/SG
Tier 1 tops	1216	1216
Tier 2 tops	1317	1317
Tier 3 tops	1468	1468

## Table top finishes for Kite, Mini Mobile and Versatilis

---

Tier 1



Designer White  
DW      Kensington Maple  
KM      Pewter Brush  
PB      Titanium Ev  
TE      Wild Cherry  
WC

Tier 2



Black  
BL      White Tigris  
WT      Fusion Maple  
FM      Misted Zephyr  
MZ      Dove Grey  
DG



Bannister Oak  
BO      Fonthill Pear  
FP      Hibiscus Cherry  
HC      Graphite Nebula  
GN

Tier 3



Whiteboard      Wilsonart premium      Formica      Pionite      Nevamar

## Alternative top finishes for Versatilis (POA)

---



Butcher Block      Steel-wrapped      Chem      ESD

## Leg finishes for Kite, Mini Mobile and Versatilis

---

Powder coated



## Leg finishes for Low Kite, Tall Kite, Tall Mini Mobile and Tall Versatilis

---

Powder coated



## Frame finishes for Kite and Mini Mobile (inc Low and Tall)

---

Powder coated



## Frame finishes for Versatilis (inc Low and Tall)

---

Powder coated

