

General

Lead time

8 weeks

Minimum order quantity

20

Test certificates

BIFMA

Greenguard

TUV

GS

Warranty

Full 5 years guarantee when used in a standard 8hr/day environment (excluding upholstery, expendable spare parts on 1 year and replaceable materials on 2 years). When used in a 24/7 environment the guarantee is reduced to 2 years.

Return policy

Order cancellation permitted before product ships subject to \$75-100 re-stocking fee per product.

Casters

The casters are categorized as type H and suitable for carpeted floors.

Nesting capability

Seat flips up to create space for nesting

Max user weight

249 lbs

Codes

SW1 Switch chair without armrest

SW2 Switch chair with armrest

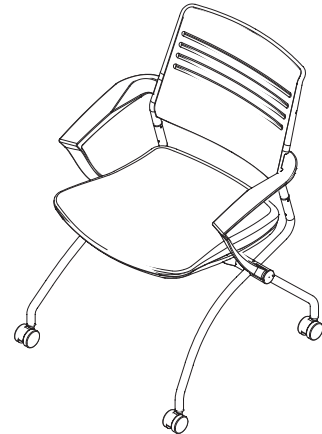

Dimensions

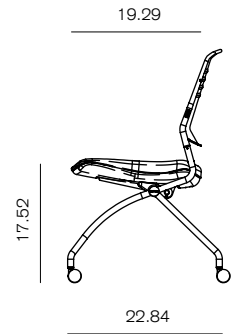
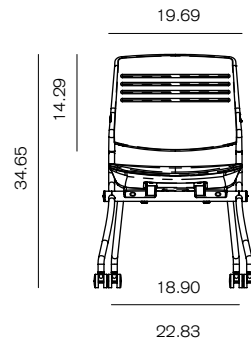
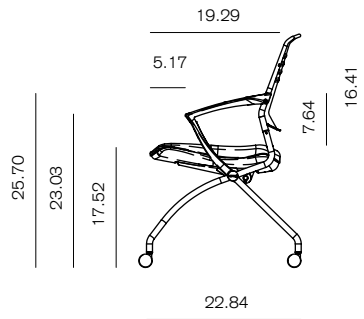
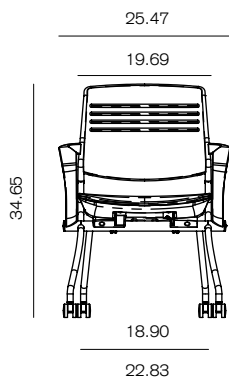
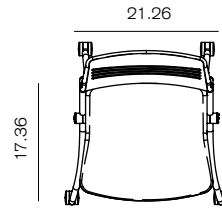
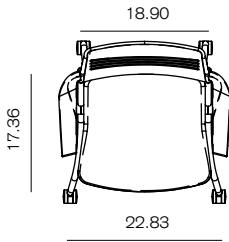

with armrest

without armrest

Nested dimensions

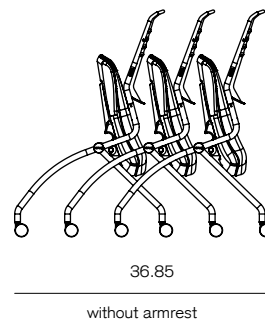
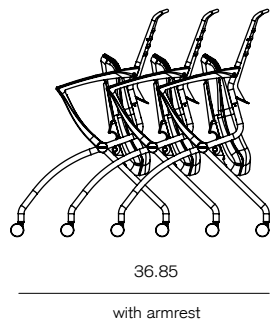

Active Back finishes



Black (BL) Dark Gray (DG) Light Gray (LG)

Fabric colours (100% polyester)



Black (BL) Gray (G) Red (R) Blue (B)

Frame finishes



Black (BL) Silver (SSL)

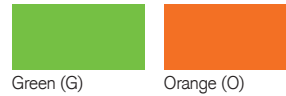

Green (G) Orange (O)

Material information

Material type	Chair component	Recycled content	Recyclable after use
Plastic (44%)	<ul style="list-style-type: none"> • Back • Seat frame • Armrest • Seat buffer & spacer • Casters 	0%	98.5% Recyclable
Steel (47.2%)	<ul style="list-style-type: none"> • Frame • Black stick • Screws & bolts 	0%	98.5% Recyclable
Foam (7.3%)	<ul style="list-style-type: none"> • PU Seat Foam 	0%	98.5% Recyclable
Upholstery (1.5%)	<ul style="list-style-type: none"> • Upholstery fabric 	0%	1.8% Non-Recyclable

*Finishes may differ slightly from images shown - samples can be provided on request

Packaged dimensions and weights

Switch chair with arms

- Box: 37.4 x 27.2 x 29.5 inch Weight: 64 lbs

Switch chair without arms

- Box: 37.4 x 27.2 x 21.7 inch Weight: 53 lbs

Chair weights (total net weight)

Switch chair with arms

57.3 lbs

Switch chair without arms

48.5 lbs

Container information

Switch chair with arms

20' = 139 pcs

40' = 279 pcs

40' HQ = 335 pcs

Switch chair without arms

20' = 174 pcs

40' = 349 pcs

40' HQ = 419 pcs

Contact info

72 Hillside Drive
Drums, PA 18222
USA

(570) 788 0888
joe@muzo-works.com

muzo-works.com